



REFRIGERATOR USER INSTRUCTIONS

THANK YOU for purchasing this high-quality product. If you should experience a problem not covered in TROUBLESHOOTING or PROBLEM SOLVER, please visit our website at www.whirlpool.com for additional information. If you still need assistance, call us at 1-800-253-1301. In Canada, visit our website at www.whirlpool.ca or call us at 1-800-807-6777.

You will need your model and serial number, located on the inside wall of the refrigerator compartment.

Para obtener acceso a "Instrucciones para el usuario del refrigerador" en español, o para obtener información adicional acerca de su producto, visite: www.whirlpool.com.

Necesitará su número de modelo y de serie, ubicado en el interior del compartimiento del refrigerador.

Table of Contents / Table des matières

REFRIGERATOR SAFETY	2	SÉCURITÉ DU RÉFRIGÉRATEUR	18
Proper Disposal of Your Old Refrigerator	3	Mise au rebut appropriée de votre vieux réfrigérateur	19
REFRIGERATOR USE	3	UTILISATION DU RÉFRIGÉRATEUR	19
Install Air Filter	3	Installation du filtre à air	19
Install Produce Preserver	4	Installation du sachet de conservation pour produits frais	20
Using the Controls	5	Utilisation des commandes	21
Convertible Drawer Temperature Control	6	Commande de température dans le tiroir convertible	23
Crisper Humidity Control	6	Réglage de l'humidité dans le bac à légumes	23
Chilled Door Bin	6	Compartiment fraîcheur dans la porte	23
Water and Ice Dispensers.....	6	Distributeurs d'eau et de glaçons.....	23
Ice Maker and Storage Bin	8	Machine à glaçons et bac d'entreposage	25
Water Filtration System.....	9	Système de filtration de l'eau	26
REFRIGERATOR CARE	9	ENTRETIEN DU RÉFRIGÉRATEUR	26
Cleaning	9	Nettoyage.....	26
Lights.....	10	Lâmpes	27
Vacation and Moving Care	10	Entretien avant les vacances ou lors d'un déménagement	27
PROBLEM SOLVER	11	RÉSOLUTION DE PROBLÈMES	28
ACCESSORIES	15	ACCESSOIRES	33
WATER FILTER CERTIFICATIONS	15	FEUILLE DE DONNÉES SUR LA PERFORMANCE	34
PERFORMANCE DATA SHEET	16	GARANTIE	35
WARRANTY	17		

REFRIGERATOR SAFETY

Your safety and the safety of others are very important.

We have provided many important safety messages in this manual and on your appliance. Always read and obey all safety messages.



This is the safety alert symbol.

This symbol alerts you to potential hazards that can kill or hurt you and others.

All safety messages will follow the safety alert symbol and either the word "DANGER" or "WARNING."

These words mean:

⚠ DANGER

You can be killed or seriously injured if you don't immediately follow instructions.

⚠ WARNING

You can be killed or seriously injured if you don't follow instructions.

All safety messages will tell you what the potential hazard is, tell you how to reduce the chance of injury, and tell you what can happen if the instructions are not followed.

IMPORTANT SAFETY INSTRUCTIONS

WARNING: To reduce the risk of fire, electric shock, or injury when using your refrigerator, follow these basic precautions:

- Plug into a grounded 3 prong outlet.
- Do not remove ground prong.
- Do not use an adapter.
- Do not use an extension cord.
- Disconnect power before servicing.
- Replace all parts and panels before operating.
- Remove doors from your old refrigerator.
- Use nonflammable cleaner.
- Keep flammable materials and vapors, such as gasoline, away from refrigerator.
- Use two or more people to move and install refrigerator.
- Disconnect power before installing ice maker (on ice maker kit ready models only).
- Use a sturdy glass when dispensing ice (on some models).
- Do not hit the refrigerator glass doors (on some models).

SAVE THESE INSTRUCTIONS

State of California Proposition 65 Warnings:

WARNING: This product contains one or more chemicals known to the State of California to cause cancer.

WARNING: This product contains one or more chemicals known to the State of California to cause birth defects or other reproductive harm.

Proper Disposal of Your Old Refrigerator

⚠ WARNING

Suffocation Hazard

Remove doors from your old refrigerator.

Failure to do so can result in death or brain damage.

IMPORTANT: Child entrapment and suffocation are not problems of the past. Junked or abandoned refrigerators are still dangerous, even if they will sit for "just a few days." If you are getting rid of your old refrigerator, please follow these instructions to help prevent accidents.

Before You Throw Away Your Old Refrigerator or Freezer:

- Take off the doors.
- Leave the shelves in place so that children may not easily climb inside.

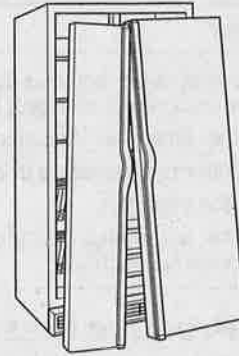

Important information to know about disposal of refrigerants:

Dispose of refrigerator in accordance with Federal and Local regulations. Refrigerants must be evacuated by a licensed, EPA certified refrigerant technician in accordance with established procedures.

REFRIGERATOR USE

Install Air Filter (on some models)

On some models, your refrigerator's accessory packet includes an air filter, which must be installed prior to use. On some models, the air filter is already installed at the factory.

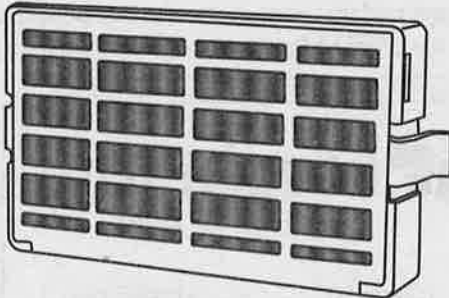

The air filter reduces the buildup of odors. This helps to maintain a cleaner environment inside the refrigerator.

Installing the Air Filter (on some models)

The filter should be installed behind the vented door, which is located (depending on your model) along either the rear or left interior wall near the top of the refrigerator compartment.

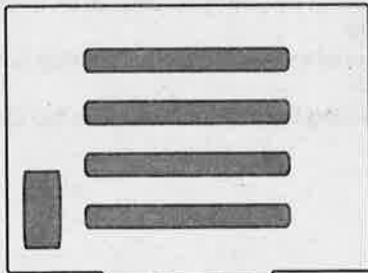

1. Remove the air filter from its packaging.
2. Lift open the vented door.

3. Snap the filter into place.

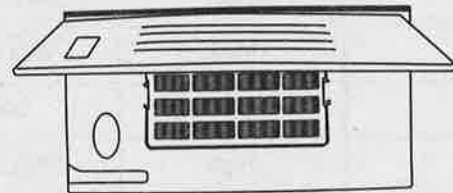

4. Close the vented door.

Installing the Filter Status Indicator (on some models)

The filter comes with a status indicator, which should be activated and installed at the same time the air filter is installed.

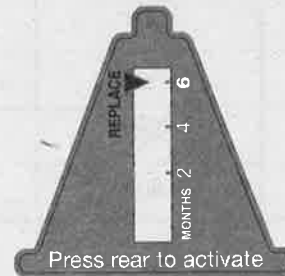

1. Place the indicator face-down on a firm, flat surface.
2. Apply pressure to the bubble on the back of the indicator, until the bubble pops to activate the indicator.
3. Lift open the vented air filter door. On some models, there are notches behind the door.
4. **On models with notches:**
 - Slide the indicator down into the notches, facing outward.

NOTE: The indicator will not easily slide into the notches if the rear bubble has not been popped.

 - Close the air filter door, and check that the indicator is visible through the rectangular hole in the door.

On models without notches:

- Store the indicator in a visible place you will easily remember - either inside the refrigerator, or elsewhere in your kitchen or home.

Replacing the Air Filter

The disposable air filter should be replaced every 6 months, when the status indicator has completely changed from white to red.

To order a replacement air filter, see "Accessories."

1. Remove the old air filter by squeezing in on the side tabs.
2. Remove the old status indicator.
3. Install the new air filter and status indicator using the instructions in the previous sections.

**Install Produce Preserver
(on some models)**

On some models, your refrigerator's accessory packet includes a Produce Preserver, which should be installed prior to use. On some models, the Produce Preserver is already installed at the factory.

The Produce Preserver absorbs ethylene, allowing the ripening process of many produce items to slow down. As a result, certain produce items will stay fresh longer.

Ethylene production and sensitivity varies depending on the type of fruit or vegetable. To preserve freshness, it is best to separate produce with sensitivity to ethylene from fruits that produce moderate to high amounts of ethylene.

	Sensitivity to Ethylene	Ethylene Production
Apples	High	Very High
Asparagus	Med.	Very Low
Berries	Low	Low
Broccoli	High	Very Low
Cantaloupe	Med.	High
Carrots	Low	Very Low
Citrus Fruit	Med.	Very Low
Grapes	Low	Very Low
Lettuce	High	Very Low
Pears	High	Very High
Spinach	High	Very Low

Installing the Produce Preserver (on some models)

CAUTION: IRRITANT

MAY IRRITATE EYES AND SKIN. DANGEROUS FUMES FORM WHEN MIXED WITH OTHER PRODUCTS.

Do not mix with cleaning products containing ammonia, bleach or acids. Do not get in eyes, on skin or clothing. Do not breathe dust. Keep out of reach of children.

FIRST AID TREATMENT: Contains potassium permanganate. If swallowed, call a Poison Control Center or doctor immediately. Do not induce vomiting. If in eyes, rinse with water for 15 minutes. If on skin, rinse with water.

The Produce Preserver pouches should be installed in their housing, which is located along an interior side wall of the crisper or convertible drawer.

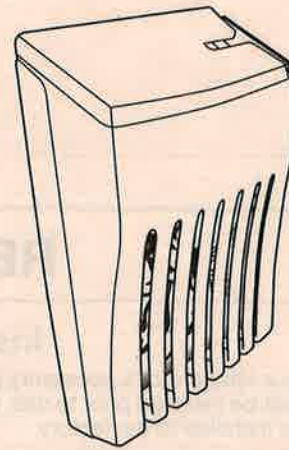

NOTE: For best performance, always use two pouches.

1. Remove the Produce Preserver pouches from their packaging.



2. Lift up on the housing in order to remove it from its mounting tab along the wall.
3. Open the housing by pulling up and out on the back of the top of the housing.
4. Place both pouches inside the housing, then snap the housing back together.
5. Place the housing back on the mounting tab along the wall.

Installing the Status Indicator (on some models)

The Produce Preserver comes with a status indicator, which should be activated and installed at the same time the pouch is installed.

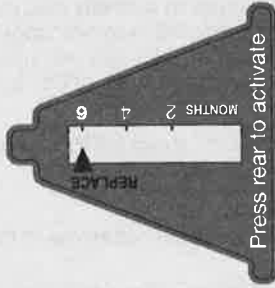

1. Place the indicator face-down on a firm, flat surface.
2. Apply pressure to the bubble on the back of the indicator, until the bubble pops to activate the indicator.
3. Slide open the cap on the Produce Preserver housing.
4. Place the indicator in the top of the housing, facing outward.
5. Slide the cap closed, and check that the indicator is visible through the rectangular hole in the cap.

NOTE: The cap will not easily close if the indicator's rear bubble has not been popped.

Replacing the Produce Preserver (on some models)

The disposable pouches should be replaced every 6 months, when the status indicator has completely changed from white to red.

To order replacements, see "Accessories."

1. Remove the old pouches from the Produce Preserver housing.
2. Remove the old status indicator.
3. Install the new pouches and status indicator using the instructions in the previous sections.

Using the Controls

The refrigerator and freezer controls are located on the dispenser panel.

IMPORTANT: The display screen on the dispenser control panel will turn off automatically and enter "sleep" mode when the control buttons and dispenser pads have not been used for 2 minutes or more. While in "sleep" mode, the first press of a control button will only reactivate the display screen, without changing any settings.

- Touch any control button on the dispenser panel to activate the display screen. The home screen will appear as shown.

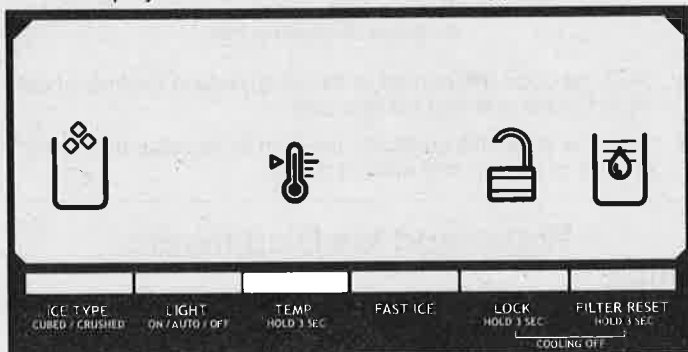

Adjusting the Controls

For your convenience, your refrigerator and freezer controls are preset at the factory. When you first install your refrigerator, make sure that the controls are still set to the "mid-settings." The factory recommended set points are 37°F (3°C) for the refrigerator and 0°F (-18°C) for the freezer.

IMPORTANT:

- Wait 24 hours before you put food into the refrigerator. If you add food before the refrigerator has cooled completely, your food may spoil.

NOTE: Adjusting the set points to a colder than recommended setting will not cool the compartments any faster.

- If the temperature is too warm or too cold in the refrigerator or freezer, first check the air vents to be sure they are not blocked before adjusting the controls.
- The preset settings should be correct for normal household usage. The controls are set correctly when milk or juice is as cold as you like and when ice cream is firm.
- Wait at least 24 hours between adjustments. Recheck the temperatures before other adjustments are made.

To view and adjust the set points, press and hold the TEMP button for 3 seconds. When adjust mode is activated, adjusting information will appear on the display screen.

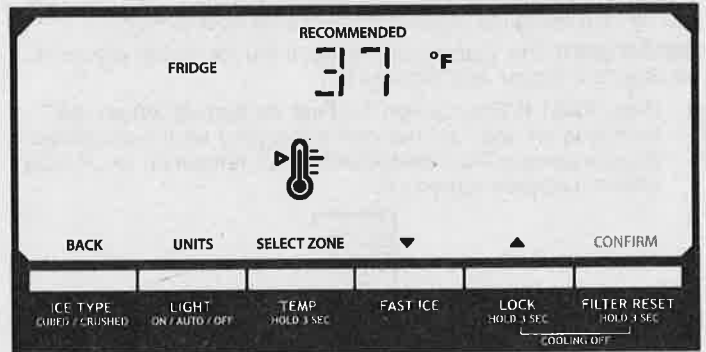

NOTE: To view Celsius temperatures, press the LIGHT button when adjust mode is activated. To return the display setting to Fahrenheit, press LIGHT again.

- When adjust mode is activated, the display screen shows the refrigerator set point and "FRIDGE" appears.
- Press LOCK to raise the set point, or press FAST ICE to lower the set point.
- When you have finished viewing (and adjusting if desired) the refrigerator set point, press TEMP to change the display to show the freezer set point. When the zone has been changed, "FREEZER" appears on the display screen.
- Press LOCK to raise the set point, or press FAST ICE to lower the set point.
- When you have finished viewing (and adjusting if desired) both the refrigerator and freezer set points, press FILTER to save the settings.

NOTE: To exit without saving changes, press ICE TYPE at any time while in adjust mode, or allow about 60 seconds of inactivity and adjust mode will turn off automatically.

When adjusting temperature set points, use the following chart as a guide.

CONDITION:	TEMPERATURE ADJUSTMENT:
REFRIGERATOR too cold	REFRIGERATOR Setting 1° higher
REFRIGERATOR too warm	REFRIGERATOR Setting 1° lower
FREEZER too cold	FREEZER Setting 1° higher
FREEZER too warm / Too little ice	FREEZER Setting 1° lower

The set point range for the refrigerator is 33°F to 45°F (0°C to 7°C). The set point range for the freezer is -5°F to 5°F (-21°C to -15°C).

Cooling On/Off

Your refrigerator and freezer will not cool when cooling is turned off.

- To turn cooling off, press and hold the LOCK and FILTER buttons at the same time for 3 seconds.

IMPORTANT: To avoid unintentionally locking the dispenser or changing other settings, be sure to press both buttons at exactly the same time.

When cooling is off, "COOLING OFF" will appear on the display screen.

- Press and hold LOCK and FILTER for 3 seconds again to turn cooling back on.

Additional Features

Fast Ice

The Fast Ice feature assists with temporary periods of heavy ice use by increasing ice production over a 24-hour period.

IMPORTANT: This feature only works if the ice maker is turned on. See "Ice Maker and Storage Bin."

- Press FAST ICE to turn on the Fast Ice feature. When the feature is on, the Fast Ice icon will appear on the dispenser display screen. The Fast Ice setting will remain on for 24 hours unless manually turned off.



- To manually turn off the Fast Ice feature, press FAST ICE again or adjust the freezer temperature set point. The Fast Ice icon will disappear when the feature is off.

NOTE: If increased ice production is desired at all times, change the freezer set point to a lower setting. Setting the freezer to a colder temperature may make some foods, such as ice cream, harder.

Door Ajar Alarm

The Door Ajar Alarm feature sounds an alarm when the refrigerator or freezer door is open for 5 minutes and the product cooling is turned on. The alarm will repeat every 2 minutes. Close both doors to turn it off. The feature then resets and will reactivate when either door is left open again for 5 minutes.

NOTE: To mute the audible alarm while keeping the doors open, such as while cleaning the inside of the refrigerator, press any button on the control panel. The alarm sound will be temporarily turned off, but the Door Ajar icon will still be displayed on the dispenser control panel.



Dual Evaporator (on some models)

Some models come equipped with a dual sequential evaporation system, which includes two separate evaporators for the refrigerator and freezer compartments.

Dual evaporation results in higher humidity, which helps keep foods in the refrigerator from spoiling as quickly and improves food quality and freshness in the freezer due to decreased freezer burn. In addition, the dual evaporation system helps keep food smells in the refrigerator from transferring to ice in the freezer.

NOTE: The dual evaporation system is always activated when your refrigerator is operating. You do not need to press any buttons to turn it on.

Convertible Drawer Temperature Control (on some models)

The control can be adjusted to properly chill meats or vegetables. The air inside the pan is cooled to avoid "spot" freezing and can be set to keep meats at the National Livestock and Meat Board recommended storage temperatures of 28° to 32°F (-2° to 0°C).

To store meat:

Set the control to one of the three MEAT settings to store meat at its optimal storage temperature.

To store vegetables:

Set the control to VEG to store vegetables at their optimal storage temperatures.

NOTE: If food starts to freeze, move the control to the right (less cold), toward the VEG setting. Remember to wait 24 hours between adjustments.

Crisper Humidity Control (on some models)

You can control the amount of humidity in the moisture-sealed crisper. Adjust the control to any setting between LOW and HIGH.

LOW (open) for best storage of fruits and vegetables with skins.

HIGH (closed) for best storage of fresh, leafy vegetables.

Chilled Door Bin (on some models)

Cool air from the freezer is directed to the refrigerator door bin directly beneath the vents.

NOTE: The dairy compartment and can rack are not associated with the Chilled Door Bin feature.

Chilled Door Bin Control

The chilled door bin control is located on the left-hand side of the refrigerator compartment.

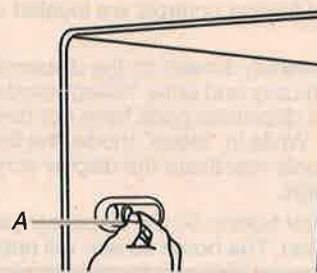

A. Chilled door bin control

- Slide the door chill control to the left to reduce the flow of cold air to the bin and make it less cold.
- Slide the door chill control to the right to increase the flow of cold air to the bin and make it colder.

Water and Ice Dispensers

NOTES:

- The dispensing system will not operate when either door (refrigerator or freezer) is open.
- Allow 24 hours for the refrigerator to cool down and chill water.
- Allow 24 hours to produce the first batch of ice. Discard the first three batches of ice produced. Wait 72 hours for full ice production.

- The display screen on the dispenser control panel will turn off automatically and enter “sleep” mode when the control buttons and dispenser pads have not been used for 2 minutes or more. While in “sleep” mode, the first press of a control button will only reactivate the display screen, without changing any settings.

Flush the Water System

Air in the water dispensing system can cause the water dispenser to drip. After connecting the refrigerator to a water source or replacing the water filter, flush the water system. Flushing the water dispensing system forces air from the water line and filter, and prepares the water filter for use.

NOTE: As air is cleared from the system, water may spurt out of the dispenser.

1. Using a sturdy container, depress and hold the water dispenser pad for 5 seconds, then release it for 5 seconds.
2. Repeat Step 1 until water begins to flow.
3. Once water begins to flow, continue depressing and releasing the dispenser pad (5 seconds on, 5 seconds off) until a total of 3 gal. (12 L) has been dispensed.

Additional flushing may be required in some households.

The Water Dispenser

IMPORTANT:

- Dispense at least 1 qt (1 L) of water every week to maintain a fresh supply.
- If the flow of water from the dispenser decreases, it could be caused by low water pressure.
 - With the water filter removed, dispense 1 cup (237 mL) of water. If 1 cup of water is dispensed in 8 seconds or less, the water pressure to the refrigerator meets the minimum requirement.
 - If it takes longer than 8 seconds to dispense 1 cup of water, the water pressure to the refrigerator is lower than recommended. See “Water Supply Requirements” or “Troubleshooting” or “Problem Solver” for suggestions.

To Dispense Water:

1. Press a sturdy glass against the water dispenser pad. Hold the glass close to the water dispenser spout to ensure that the water dispenses into the glass.

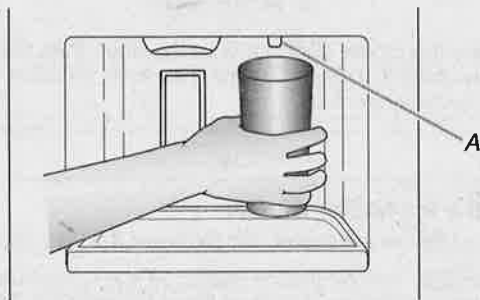

A. Water dispenser spout

2. Remove the glass to stop dispensing.

The Ice Dispenser

Ice dispenses from the ice maker storage bin in the freezer when the dispenser pad is pressed. To turn off the ice maker, see “Ice Maker and Storage Bin.”

Your ice maker can produce both crushed and cubed ice. Before dispensing ice, select which type of ice you prefer by pressing the ICE TYPE button.

The display screen indicates which type of ice is selected.

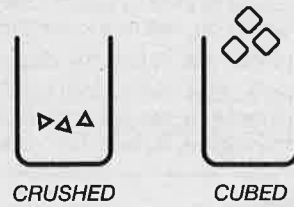

For crushed ice, cubes are crushed before being dispensed. This may cause a slight delay when dispensing crushed ice. Noise from the ice crusher is normal, and pieces of ice may vary in size. When changing from crushed to cubed, a few ounces of crushed ice will be dispensed along with the first cubes.

To Dispense Ice:

1. Make sure the desired type of ice is selected. To switch between cubed and crushed, press ICE TYPE.

⚠ WARNING

Cut Hazard

Use a sturdy glass when dispensing ice.

Failure to do so can result in cuts.

2. Press a sturdy glass against the ice dispenser pad. Hold the glass close to the ice guide to ensure that the ice dispenses into the glass.

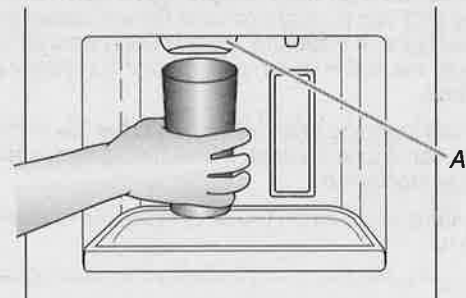

A. Ice guide

IMPORTANT: You do not need to apply a lot of pressure to the pad in order to activate the ice dispenser. Pressing hard will not make the ice dispense faster or in greater quantities.

3. Remove the glass to stop dispensing.

NOTE: Ice may continue to dispense for several seconds after removing the glass from the pad. The dispenser may continue to make noise for a few seconds after dispensing.

The Dispenser Light

When you use the dispenser, the light will automatically turn on. If you want the light to be on continuously, you may choose either ON or DIM. The display screen indicates which mode is selected.

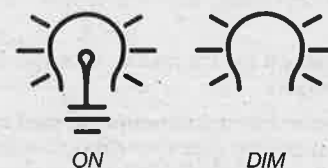

ON: Press LIGHT to turn the dispenser light on.

DIM: Press LIGHT a second time to select DIM mode. The dispenser light will remain on, but at a lower intensity.

OFF: Press LIGHT a third time to turn the dispenser light off.

The dispenser lights are LEDs that cannot be changed. If it appears that your dispenser lights are not working, see "Troubleshooting" or "Problem Solver" for more information.

The Dispenser Lock

The dispenser can be turned off for easy cleaning or to avoid unintentional dispensing by small children and pets.

NOTE: The lock feature does not shut off power to the refrigerator, to the ice maker, or to the dispenser light. It simply deactivates the controls and dispenser pads. To turn off the ice maker, see "Ice Maker and Storage Bin."

- Press and hold LOCK for 3 seconds to lock the dispenser.
- Press and hold LOCK a second time to unlock the dispenser.

The display screen indicates when the dispenser is locked.

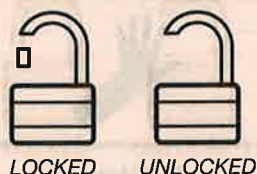

Ice Maker and Storage Bin

- Allow 24 hours to produce the first batch of ice. Discard the first three batches of ice produced.
- The quality of your ice will be only as good as the quality of the water supplied to your ice maker. Avoid connecting the ice maker to a softened water supply. Water softener chemicals (such as salt) can damage parts of the ice maker and lead to poor quality ice. If a softened water supply cannot be avoided, make sure the water softener is operating properly and is well maintained.
- Do not use anything sharp to break up the ice in the storage bin. This can cause damage to the ice container and the dispenser mechanism.
- Do not store anything on top of or in the ice maker or storage bin.

Style 1

Turning the Ice Maker On/Off:

The On/Off switch can only be accessed when the ice storage bin has been removed. The switch is located on the freezer door, on the left side of the wall that surrounds the ice storage bin. See the following section for bin removal instructions.

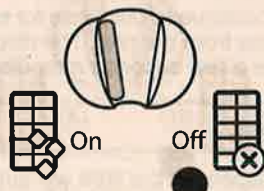

Ice Maker Control

- To turn on the ice maker, slide the control to the ON (left) position.
- To manually turn off the ice maker, slide the control to the OFF (right) position.

NOTE: The ice maker has an automatic shutoff to keep the storage bin from overflowing during normal operation. The ice maker sensors will automatically stop ice production, but the control will remain in the ON (left) position.

Removing and Replacing the Ice Storage Bin:

1. Press down the release lever and tilt the bucket outward. Use both hands to hold the base of the storage bin, then lift it up and out.

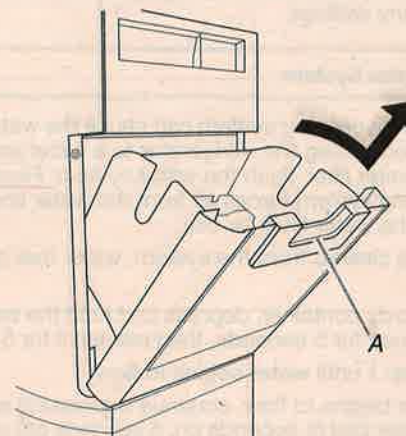

A. Release lever

NOTE: It is not necessary to turn the ice maker control to the OFF (right) position when removing the storage bin. The sensor cover ("flipper door"), located on the right wall of the freezer door, stops the ice maker from producing ice if the door is open or the storage bin is removed.

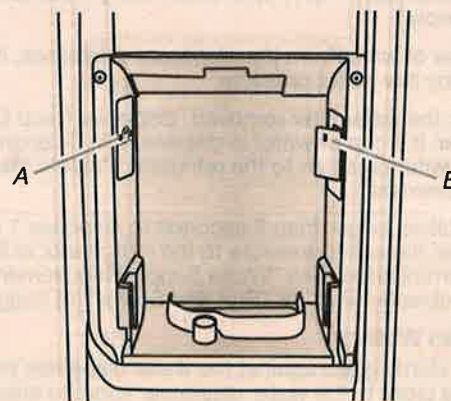

A. On/Off switch
B. Sensor cover

2. Replace the bin by sliding it onto the door, then tilting it back into an upright position. The release lever will click when the bin is securely in place.

Style 2

Turning the Ice Maker On/Off:

- To turn ON the ice maker, simply lower the wire shutoff arm.
- To manually turn off the ice maker, lift the wire shutoff arm to the OFF (arm up) position and listen for the click. Ice can still be dispensed, but no more can be made.

NOTE: The ice maker has an automatic shutoff to keep the storage bin from overflowing during normal operation. As ice is made, the ice cubes will fill the ice storage bin, and the ice cubes will raise the wire shutoff arm to the OFF (arm up) position. Do not force the wire shutoff arm up or down.

Removing and Replacing the Ice Storage Bin:

1. Pull the covering panel up from the bottom.
2. Lift the wire shutoff arm so it clicks into the OFF (up) position.
3. Lift up the front of the storage bin and pull it out.

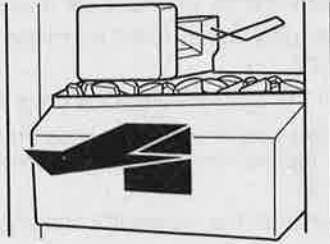

4. Replace the bin by pushing it in all the way or the dispenser will not work.
5. To restart ice production, push the wire shutoff arm down to the ON position. Make sure the door is closed tightly.

Water Filtration System

Do not use with water that is microbiologically unsafe or of unknown quality without adequate disinfection before or after the system. Systems certified for cyst reduction may be used on disinfected waters that may contain filterable cysts.

Water Filter Status Light

The water filter status light will help you know when to change your water filter.

- When the dispenser control panel's water filter status display changes to "ORDER," this tells you that it is almost time to change the water filter cartridge.
- Replace the water filter cartridge when the water filter status display changes to "REPLACE."

NOTE: If water flow to your water dispenser or ice maker decreases noticeably, change the filter sooner. The filter should be replaced at least every 6 months, depending on your water quality and usage.

Resetting the Filter Status

- After changing the water filter, reset the status light by pressing and holding the FILTER button for 3 seconds.
- When the system is reset, the "ORDER" and "REPLACE" icons will disappear from the display screen.

Changing the Water Filter

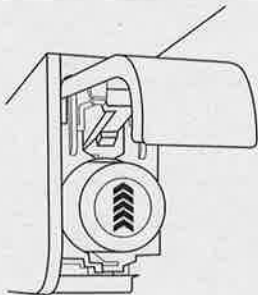

1. Locate the water filter in the top-right corner of the refrigerator compartment.
 2. Lift open the filter cover door. The filter will be released and then be ejected as the door is opened.
 3. When the door is completely open, pull the filter straight out.
- NOTE:** There may be some water in the filter. Some spilling may occur. Use a towel to wipe up any spills.

4. Take the new filter out of its packaging and remove the covers from the O-rings. Be sure the O-rings are still in place after the covers are removed.
5. With the arrow pointing up, align the new filter with the filter housing and slide it into place. The filter cover door will automatically begin to close as the new filter is inserted.
6. Close the filter cover door completely in order to snap the filter into place. You may need to press hard.
7. Flush the water system. See "Water and Ice Dispensers."

REFRIGERATOR CARE

Cleaning

⚠ WARNING



Explosion Hazard

Use nonflammable cleaner.

Failure to do so can result in death, explosion, or fire.

Both the refrigerator and freezer sections defrost automatically. However, clean both sections about once a month to avoid buildup of odors. Wipe up spills immediately.

IMPORTANT: Because air circulates between both sections, any odors formed in one section will transfer to the other. You must thoroughly clean both sections to eliminate odors. To avoid odor transfer and drying out of food, wrap or cover foods tightly.

To Clean Your Refrigerator:

NOTE: Do not use abrasive or harsh cleaners such as window sprays, scouring cleansers, flammable fluids, cleaning waxes, concentrated detergents, bleaches or cleansers containing petroleum products on plastic parts, interior and door liners or gaskets. Do not use paper towels, scouring pads, or other harsh cleaning tools.

1. Unplug refrigerator or disconnect power.
2. Hand wash, rinse, and dry removable parts and interior surfaces thoroughly. Use a clean sponge or soft cloth and a mild detergent in warm water.
3. Wash stainless steel and painted metal exteriors with a clean sponge or soft cloth and a mild detergent in warm water.
4. There is no need for routine condenser cleaning in normal home operating environments. If the environment is particularly greasy or dusty, or there is significant pet traffic in the home, the condenser should be cleaned every 2 to 3 months to ensure maximum efficiency.

If you need to clean the condenser:

- Remove the base grille. See the "Door Removal" instructions, either in the User Instructions or the Installation Instructions and Owner's Manual, or in the separate instruction sheet provided with your refrigerator.
 - Use a vacuum cleaner with a soft brush to clean the grille, the open areas behind the grille and the front surface area of the condenser.
 - Replace the base grille when finished.
5. Plug in refrigerator or reconnect power.

Lights

The interior and dispenser lights are LEDs that cannot be changed.

- If the dispenser lights do not appear to be working as described in “Water and Ice Dispensers” (in the User Instructions, User Guide, or Use & Care Guide) or if the interior lights do not illuminate when either door is opened, call for assistance or service. See either the front cover or the Warranty for contact information.

Vacation and Moving Care

Vacations

If You Choose to Leave Refrigerator On While You Are Away:

1. Use up any perishables and freeze other items.
2. If your refrigerator has an automatic ice maker and is connected to the household water supply, turn off the water supply to the refrigerator. Property damage can occur if the water supply is not turned off.
3. If you have an automatic ice maker, turn off the ice maker.
NOTE: Depending on your model, raise the wire shutoff arm to OFF (up) position or press the switch to OFF (right).
4. Empty the ice bin.

If You Choose to Turn Refrigerator Off Before You Leave:

1. Remove all food from the refrigerator.
2. If your refrigerator has an automatic ice maker:
 - Turn off the water supply to the ice maker at least one day ahead of time.
 - When the last load of ice drops, raise the wire shutoff arm to the OFF (up) position or move the switch to the OFF (right) setting.
3. Depending on the model, turn the Refrigerator Control to OFF or turn cooling off. See “Using the Controls” in the User Instructions, User Guide, or Use & Care Guide.
4. Clean refrigerator, wipe it, and dry well.
5. Tape rubber or wood blocks to the tops of both doors to prop them open far enough for air to get in. This stops odor and mold from building up.

Moving

When you are moving your refrigerator to a new home, follow these steps to prepare it for the move.

1. If your refrigerator has an automatic ice maker:
 - Turn off the water supply to the ice maker at least one day ahead of time.
 - Disconnect the water line from the back of the refrigerator.
 - When the last load of ice drops, raise the wire shutoff arm to the OFF (up) position or move the switch to the OFF (right) setting.
2. Remove all food from the refrigerator and pack all frozen food in dry ice.
3. Empty the ice bin.
4. Depending on the model, turn the Refrigerator Control to OFF or turn cooling off. See “Using the Controls” in the User Instructions, User Guide, or Use & Care Guide.
5. Unplug refrigerator.
6. Clean, wipe, and dry thoroughly.
7. Take out all removable parts, wrap them well, and tape them together so they don't shift and rattle during the move.
8. Depending on the model, raise the front of the refrigerator so it rolls more easily OR screw in the leveling legs so they don't scrape the floor. See “Adjust the Doors” or “Door Removal, Leveling and Alignment.”
9. Tape the doors closed and tape the power cord to the back of the refrigerator.

When you get to your new home, put everything back and refer to the Installation Instructions for preparation instructions. Also, if your refrigerator has an automatic ice maker, remember to reconnect the water supply to the refrigerator.

PROBLEM SOLVER

First try the solutions suggested here or visit our website and reference FAQs (Frequently Asked Questions) to possibly avoid the cost of a service call.

In the U.S.A., www.whirlpool.com In Canada, www.whirlpool.ca

⚠ WARNING



Electrical Shock Hazard

Plug into a grounded 3 prong outlet.

Do not remove ground prong.

Do not use an adapter.

Do not use an extension cord.

Failure to follow these instructions can result in death, fire, or electrical shock.

GENERAL OPERATION

Possible Causes and/or Recommended Solutions

Refrigerator will not operate

- **Not connected to an electrical supply** - Plug the power cord into a grounded 3 prong outlet. Do not use an extension cord.
- **No power to the electrical outlet** - Plug in a lamp to see if the outlet is working.
- **Household fuse has blown or circuit breaker has tripped** - Replace the fuse or reset the circuit breaker. If the problem continues, contact a licensed electrician.
- **Control or cooling is not turned on** - Turn on the refrigerator control, or turn cooling on. See "Using the Controls."
- **New installation** - Following installation, allow 24 hours for the refrigerator and freezer to cool completely.

NOTE: Adjusting the temperature control(s) to the coldest setting will not cool either compartment (refrigerator or freezer) more quickly.

Motor seems to run too much

- **Your new refrigerator has an energy-efficient motor** - The refrigerator may run longer than you're used to, because the compressor and fans operate at lower speeds that are more energy-efficient. This is normal.

NOTE: Your refrigerator may run even longer if the room is warm, a large load of food is added, the doors are opened often, or if a door has been left open.

Refrigerator seems noisy

The compressor in your new refrigerator regulates temperature more efficiently and uses less energy than older models. During various stages of operation, you may hear normal operating sounds that are unfamiliar.

The following noises are normal:

- **Buzzing/Clicking** - Heard when the water valve opens and closes to dispense water or fill the ice maker. If the refrigerator is connected to a water line, this is normal. If the refrigerator is not connected to a water line, turn off the ice maker.
- **Cracking/Crashing** - Heard when ice is ejected from the ice maker mold.
- **Popping** - Heard when the inside walls contract/expand, especially during initial cooldown.
- **Pulsating/Whirring** - Heard when the fans/compressor adjust to optimize performance during normal operation.
- **Rattling** - Heard when water passes through the water line, or due to the flow of refrigerant. Rattling may also come from items placed on top of the refrigerator.
- **Water running or gurgling** - Heard when ice melts during the defrost cycle and water runs into the drain pan.
- **Sizzling** - Heard when water drips onto the heater during the defrost cycle.

GENERAL OPERATION**Possible Causes and/or Recommended Solutions**

Temperature is too warm

- **New installation** - Following installation, allow 24 hours for the refrigerator and freezer to cool completely.
NOTE: Adjusting the temperature control(s) to the coldest setting will not cool either compartment (refrigerator or freezer) more quickly.
- **Doors are opened often or not closed completely** - This allows warm air to enter the refrigerator. Minimize door openings, keep the doors fully closed, and make sure both doors are properly sealed.
- **Air vents are blocked** - Remove items that are immediately in front of the vents.
- **Large amount of warm food recently added** - Allow several hours for the refrigerator to return to its normal temperature.
- **Controls are not set correctly for the surrounding conditions** - Adjust the controls to a colder setting. Check the temperature again in 24 hours.

Temperature is too cold

- **Controls are not set correctly for the surrounding conditions** - Adjust the controls to a warmer setting. Check the temperature again in 24 hours.
- **Top refrigerator shelf is colder than lower shelves** - On some models, air from the freezer enters the refrigerator compartment through vents near the top refrigerator shelf. As a result, the top shelf can be slightly colder than lower shelves.
- **Air vents are blocked** - Remove items that are immediately in front of the vents.

Interior moisture buildup

NOTE: Some moisture buildup is normal. Clean with a soft dry cloth.

- **Room is humid** - A humid environment contributes to moisture buildup. Use the refrigerator only in an indoor location, with as little humidity as possible.
- **Doors are opened often or not closed completely** - This allows humid air to enter the refrigerator. Minimize door openings, keep the doors fully closed, and make sure both doors are properly sealed.

Interior lights do not work

- **Doors have been open for an extended period of time** - Close the doors to reset the lights.
- **Light bulb is loose in the socket or has burned out** - On models with incandescent interior light bulbs, tighten or replace the bulb. See "Lights."

NOTE: On models with LED lights, call for assistance or service if the interior lights do not illuminate when either door is opened. See either the front cover or the Warranty for contact information.

Dispenser lights do not work (on some models)

- **Dispenser light is turned off** - On some models, if the dispenser light is set to OFF, the light will turn on only when a dispenser pad/lever is pressed. If you want the dispenser light to stay on continuously, select a different setting. See "Water and Ice Dispensers."
- **Dispenser light is set to AUTO or NIGHT LIGHT** - On some models, if the dispenser light is set to AUTO or NIGHT LIGHT, make sure the dispenser light sensor is not blocked. See "Water and Ice Dispensers."

NOTE: On models with LED lights, call for assistance or service if the dispenser lights do not operate correctly. See either the front cover or the Warranty for contact information.

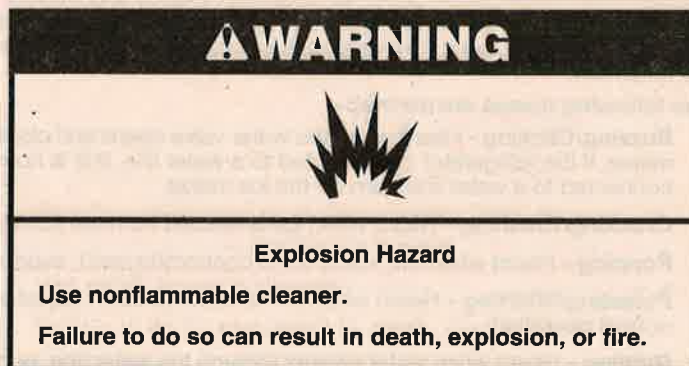

DOORS AND LEVELING**Possible Causes and/or Recommended Solutions**

Doors are difficult to open

- **Gaskets are dirty or sticky** - Clean the gaskets and contact surfaces with mild soap and warm water. Rinse and dry with a soft cloth.

DOORS AND LEVELING**Possible Causes and/or Recommended Solutions**

Doors will not close completely

- **Door is blocked open** - Move food packages away from the door. Make sure all bins and shelves are in their correct positions. Make sure all packaging materials have been removed.

Doors appear to be uneven

- **Doors need to be aligned, or refrigerator needs to be leveled** - See the leveling and door alignment instructions.

Refrigerator rocks and is not stable

- **Refrigerator is not level** - To stabilize the refrigerator, remove the base grille and lower the leveling feet until they touch the floor. See the leveling and door alignment instructions.
-

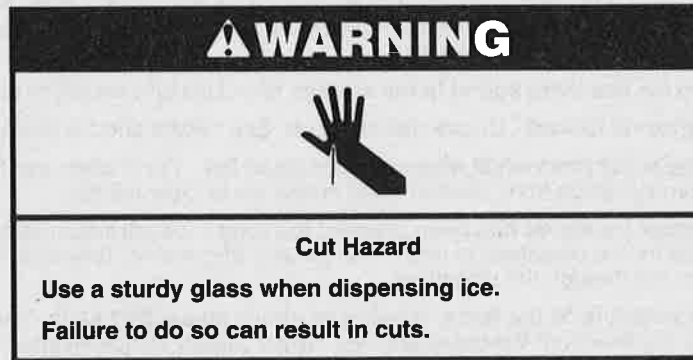
**ICE AND WATER****Possible Causes and/or Recommended Solutions**

Ice maker is not producing ice, not producing enough ice, or producing small/hollow ice

- **Refrigerator is not connected to a water supply, or the water supply shutoff valve is not fully turned on** - Connect the refrigerator to a water supply and make sure the water shutoff valve is fully open.
- **Kink in the water source line** - A kink in the water line can reduce water flow, resulting in decreased ice production, small ice cubes, and/or hollow or irregularly-shaped ice. Straighten the water line.
- **Ice maker is not turned on** - Turn on the ice maker. See "Ice Maker and Storage Bin."
- **New installation** - After connecting the refrigerator to a water source, flush the water system. (See "Water and Ice Dispensers.") Wait 24 hours for ice production to begin. Wait 72 hours for full ice production. Discard the first three batches of ice produced.
- **Large amount of ice was recently removed** - Allow sufficient time for the ice maker to produce more ice.
- **Ice is jammed in the ice maker ejector arm** - Remove ice from the ejector arm using a plastic utensil.
- **Inadequate water pressure** - Verify that the household has adequate water pressure. See "Water Supply Requirements."
- **Water filter is installed incorrectly** - Make sure the filter is properly installed. See "Water Filtration System."
- **A reverse osmosis water filtration system is connected to your cold water supply** - This can decrease water pressure. See "Water Supply Requirements."

NOTE: If questions remain regarding water pressure, contact a licensed, qualified plumber.

ICE AND WATER**Possible Causes and/or Recommended Solutions**

Ice dispenser will not operate properly

- **Doors not closed completely** - Make sure both doors are firmly closed. (On some models, only the freezer door must be closed in order to operate the dispenser.)
- **New installation** - After connecting the refrigerator to a water source, flush the water system. (See "Water and Ice Dispensers.") Wait 24 hours for ice production to begin. Wait 72 hours for full ice production. Discard the first three batches of ice produced.
- **Ice maker is not turned on, or ice bin is not installed correctly** - Turn on the ice maker and make sure the ice storage bin is firmly in position. See "Ice Maker and Storage Bin."
- **Ice is clogged or frozen together in the ice storage bin, or ice is blocking the ice delivery chute** - Remove or separate the clogged ice, using a plastic utensil if necessary. Clean the ice delivery chute and the bottom of the ice storage bin using a warm damp cloth, then dry both thoroughly. To avoid clogging and to maintain a fresh supply of ice, empty the storage bin and clean both the storage bin and the delivery chute every 2 weeks.
- **Wrong ice has been added to the storage bin** - Use only ice cubes produced by the current ice maker.
- **Dispenser is locked** - Unlock the dispenser. See "Water and Ice Dispensers."
- **Ice dispenser jams while dispensing crushed ice** - For models with the ice storage bin on the door, temporarily switch from crushed ice to cubed ice to clear the jam.
- **Dispenser pad/lever has been pressed too long** - Ice will automatically stop dispensing. Wait a few minutes for the dispenser to reset, then resume dispensing. Take large amounts of ice directly from the ice bin, not through the dispenser.
- **Water pressure to the home is not at or above 30 psi (207 kPa)** - The water pressure to the home affects the flow from the dispenser. See "Water Supply Requirements."
- **Water filter is clogged or incorrectly installed** - Replace filter or reinstall it correctly. See "Water Filtration System."

Ice or water has an off-taste, odor, or gray color

- **New plumbing connections** - New plumbing connections can result in off-flavored or discolored ice or water. This problem should go away over time.
- **Ice has been stored too long** - Discard the ice and wash the ice bin. Allow 24 hours for the ice maker to produce new ice.
- **Odor has transferred from food** - Use airtight moisture-proof packaging to store food.
- **Use of non-recommended water supply line** - Odors and tastes can transfer from certain materials used in non-recommended water supply lines. Use only a recommended water supply line. See "Water Supply Requirements."
- **There are minerals (such as sulfur) in the water** - A water filter may need to be installed in order to remove the minerals.
- **Water filter was recently installed or replaced** - Gray or dark discoloration in ice or water indicates that the water filtration system needs additional flushing. See "Water and Ice Dispensers."

Water dispenser will not operate properly

- **Doors not closed completely** - Make sure both doors are firmly closed. (On some models, only the freezer door must be closed in order to operate the dispenser.)
- **Refrigerator is not connected to a water supply, or the water supply shutoff valve is not turned on** - Connect the refrigerator to a water supply and make sure the water shutoff valve is fully open.
- **Kink in the water source line** - A kink in the water line can reduce water flow to the dispenser. Straighten the water line.
- **Water pressure to the home is not at or above 30 psi (207 kPa)** - The water pressure to the home affects the flow from the dispenser. See "Water Supply Requirements."
- **New installation** - After connecting the refrigerator to a water source, flush the water system. See "Water and Ice Dispensers."
- **Dispenser is locked** - Unlock the dispenser. See "Water and Ice Dispensers."
- **Water filter is clogged or incorrectly installed** - Replace filter or reinstall it correctly. See "Water Filtration System."
- **A reverse osmosis water filtration system is connected to your cold water supply** - This can decrease water pressure. See "Water Supply Requirements."

NOTE: If questions remain regarding water pressure, contact a licensed, qualified plumber.

ICE AND WATER

Possible Causes and/or Recommended Solutions

Water is leaking or dripping from the dispenser

NOTE: After dispensing, a few additional drops of water are normal.

- **Glass was not held under the dispenser long enough** - Hold the glass under the dispenser for 2 to 3 seconds after releasing the dispenser pad/lever.
- **New installation, or water filter was recently installed or replaced** - Air in the water lines causes the water dispenser to drip. Flush the water system to remove the air in the water lines. See "Water and Ice Dispensers."
- **Residual ice in the dispenser chute is melting** - Make sure the ice chute is free of ice shavings or pieces.

Water is leaking from the back of the refrigerator

- **Water line connections are not fully tightened** - Make sure all connections are firmly tightened. See "Connect Water Supply."

Water from the dispenser is not cool enough (on some models)

NOTE: Water from the dispenser is chilled to 50°F (10°C).

- **New installation** - Allow 24 hours after installation for the water supply to cool completely.
- **Recently dispensed a large amount of water** - Allow 24 hours for the new water supply to cool completely.
- **Water has not been recently dispensed** - The first glass of water may not be cool. Discard the first glass of water dispensed.
- **Refrigerator is not connected to a cold water pipe** - Make sure the refrigerator is connected to a cold water pipe. See "Water Supply Requirements."

ACCESSORIES

The following accessories are available for your refrigerator. To order an accessory, call **1-800-442-9991** and ask for the part number listed below or contact your authorized Whirlpool dealer. In Canada, call **1-800-807-6777**.

affresh® Stainless Steel Cleaner:

Order Part #W10355016

In Canada, order Part #W10355016B

affresh® Stainless Steel Wipes:

Order Part #W10355049

In Canada, order Part #W10355049B

affresh® Kitchen & Appliance Cleaner:

Order Part #W10355010

In Canada, order Part #W10355010B

Water Filter:

Order Part #W10295370A (P4RFWB)

Air Filter:

Order Part #W10311524

Produce Preserver:

Order Part #W10346771

WATER FILTER CERTIFICATIONS

State of California
Department of Public Health
Water Treatment Device
Certificate Number

10- 2030

Date Issued: February 26, 2010

Trademark/Model Designation	Replacement Elements
PSWB2L	P4RFWB

Manufacturer: Whirlpool Corporation

The water treatment device(s) listed on this certificate have met the testing requirements pursuant to Section 116830 of the Health and Safety Code for the following health related contaminants:

Microbiological Contaminants and Turbidity

Cysts

Inorganic/Radiological Contaminants

Asbestos

Lead

Organic Contaminants

Atrazine

Lindane

Toxaphene

2, 4 - D

Rated Service Capacity: 200 gal

Rated Service Flow: 0.5 gpm

Conditions of Certification:

Do not use where water is microbiologically unsafe or with water of unknown quality, except that systems certified for cyst reduction may be used on disinfected waters that may contain filterable cysts.

PERFORMANCE DATA SHEET

Water Filtration System Model P5WB2L/P4RFB Capacity 200 Gallons (757 Liters)



System tested and certified by NSF International against NSF/ANSI Standard 42 for the reduction of Chlorine Taste and Odor, and Particulate Class I*; and against NSF/ANSI Standard 53 for the reduction of Live Cysts, Asbestos, Lead, Lindane, Toxaphene, Atrazine, and 2,4 - D.

This system has been tested according to NSF/ANSI Standards 42 and 53 for the reduction of the substances listed below. The concentration of the indicated substances in water entering the system was reduced to a concentration less than or equal to the permissible limit for water leaving the system, as specified in NSF/ANSI Standards 42 and 53.

Substance Reduction Aesthetic Effects	NSF Reduction Requirements	Average Influent	Influent Challenge Concentration	Maximum Effluent	Minimum % Reduction	Average % Reduction
Chlorine Taste/Odor	50% reduction	2.0 mg/L	2.0 mg/L ± 10%	0.20 mg/L	97	97.2
Particulate Class I*	85% reduction	7,300,000 #/mL	At least 10,000 particles/mL	75,000 #/mL**	99	99.4
Contaminant Reduction	NSF Reduction Requirements	Average Influent	Influent Challenge Concentration	Maximum Effluent	Minimum % Reduction	Average % Reduction
Live Cysts†	99.95%	160,000/L	50,000/L min.	54/L†	99.97	99.99
Asbestos	99%	87 MFL	10' to 10 ⁸ fibers/L††	0.17 MFL	99	99
Lead: @ pH 6.5	0.010 mg/L	0.160 mg/L	0.15 mg/L ± 10%	0.001 mg/L	99.4	99.4
Lead: @ pH 8.5	0.010 mg/L	0.140 mg/L	0.15 mg/L ± 10%	0.005 mg/L	98.6	98.6
Lindane	0.0002 mg/L	0.0019 mg/L	0.002 mg/L ± 10%	0.00002 mg/L	98.9	99
Toxaphene	0.003 mg/L	0.014 mg/L	0.015 mg/L ± 10%	0.001 mg/L	93	93
Atrazine	0.003 mg/L	0.0094 mg/L	0.009 mg/L ± 10%	0.0005 mg/L	94.5	94.7
2,4 - D	0.07 mg/L	0.220 mg/L	0.210 mg/L ± 10%	0.028 mg/L	87.5	96.1

Test Parameters: pH = 7.5 ± 0.5 unless otherwise noted. Flow = 0.5 gpm (1.9 Lpm). Pressure = 60 psig (413.7 kPa). Temp. = 68°F to 71.6°F (20°C to 22°C). Rated service capacity = 200 gallons (757 liters).

- It is important that operational, maintenance, and filter replacement requirements be carried out for the product to perform as advertised. Property damage can occur if all instructions are not followed.
- Use replacement filter P4RFB, part #W10295370A. 2013 suggested retail price of \$39.99 U.S.A./\$49.99 Canada. Prices are subject to change without notice.
 - Style 1** – When the water filter status display changes from “GOOD” to “ORDER,” order a new filter. When the filter indicator reads “REPLACE,” it is recommended that you replace the filter.
 - Style 2** – When the filter indicator changes from green to yellow, order a new filter. When the indicator changes from yellow to red, it is recommended that you replace the filter.
 - Style 3** – When the filter indicator reads 10%, order a new filter. When the indicator reads 0%, it is recommended that you replace the filter.
 - Style 4** – Press FILTER to check the status of your water filter. If the filter indicator light is yellow, order a new filter. If the filter indicator light is red, it is recommended that you replace the filter.
- After changing the water filter, flush the water system. See “Water and Ice Dispensers” or “Water Dispenser” in the User Instructions or User Guide.
- These contaminants are not necessarily in your water supply. While testing was performed under standard laboratory conditions, actual performance may vary.
- The product is for cold water use only.
- The water system must be installed in compliance with state and local laws and regulations.
- Do not use with water that is microbiologically unsafe or of unknown quality without adequate disinfection before or after the system. Systems certified for cyst reduction may be used on disinfected waters that may contain filterable cysts.
- Refer to the “Warranty” section (in the User Instructions or User Guide) for the Manufacturer’s name, address and telephone number.
- Refer to the “Warranty” section (in the User Instructions or User Guide) for the Manufacturer’s limited warranty.

Application Guidelines/Water Supply Parameters

Water Supply	City or Well
Water Pressure	30 - 120 psi (207 - 827 kPa)
Water Temperature	33° - 100°F (0.6° - 37.8°C)
Service Flow Rate	0.5 gpm (1.9 Lpm) @ 60 psi



*Class I particle size: >0.5 to <1 um

**Test requirement is at least 100,000 particles/mL of AC Fine Test Dust.

†Based on the use of Cryptosporidium parvum oocysts

††Fibers greater than 10 um in length

WHIRLPOOL CORPORATION MAJOR APPLIANCE WARRANTY

LIMITED WARRANTY

For one year from the date of purchase, when this major appliance is operated and maintained according to instructions attached to or furnished with the product, Whirlpool Corporation or Whirlpool Canada LP (hereafter "Whirlpool") will pay for Factory Specified Parts and repair labor to correct defects in materials or workmanship that existed when this major appliance was purchased. Service must be provided by a Whirlpool designated service company. YOUR SOLE AND EXCLUSIVE REMEDY UNDER THIS LIMITED WARRANTY SHALL BE PRODUCT REPAIR AS PROVIDED HEREIN. This limited warranty is valid only in the United States or Canada and applies only when the major appliance is used in the country in which it was purchased. Proof of original purchase date is required to obtain service under this limited warranty.

ITEMS EXCLUDED FROM WARRANTY

This limited warranty does not cover:

1. Replacement parts or repair labor if this major appliance is used for other than normal, single-family household use or when it is used in a manner that is inconsistent to published user or operator instructions and/or installation instructions.
2. Service calls to correct the installation of your major appliance, to instruct you on how to use your major appliance, to replace or repair house fuses, or to correct house wiring or plumbing.
3. Service calls to repair or replace appliance light bulbs, air filters or water filters. Consumable parts are excluded from warranty coverage.
4. Damage resulting from accident, alteration, misuse, abuse, fire, flood, acts of God, improper installation, installation not in accordance with electrical or plumbing codes, or use of products not approved by Whirlpool.
5. Cosmetic damage, including scratches, dents, chips or other damage to the finish of your major appliance, unless such damage results from defects in materials or workmanship and is reported to Whirlpool within 30 days from the date of purchase.
6. Any food or medicine loss due to refrigerator or freezer product failures.
7. Pickup and delivery. This major appliance is intended to be repaired in your home.
8. Repairs to parts or systems resulting from unauthorized modifications made to the appliance.
9. Expenses for travel and transportation for product service if your major appliance is located in a remote area where service by an authorized Whirlpool servicer is not available.
10. The removal and reinstallation of your major appliance if it is installed in an inaccessible location or is not installed in accordance with Whirlpool's published installation instructions.
11. Replacement parts or repair labor on major appliances with original model/serial numbers that have been removed, altered or cannot be easily determined.
12. Discoloration, rust, or oxidation of stainless steel surfaces.

The cost of repair or replacement under these excluded circumstances shall be borne by the customer.

DISCLAIMER OF IMPLIED WARRANTIES

IMPLIED WARRANTIES, INCLUDING ANY IMPLIED WARRANTY OF MERCHANTABILITY OR IMPLIED WARRANTY OF FITNESS FOR A PARTICULAR PURPOSE, ARE LIMITED TO ONE YEAR OR THE SHORTEST PERIOD ALLOWED BY LAW. Some states and provinces do not allow limitations on the duration of implied warranties of merchantability or fitness, so this limitation may not apply to you. This warranty gives you specific legal rights, and you also may have other rights that vary from state to state or province to province.

LIMITATION OF REMEDIES; EXCLUSION OF INCIDENTAL AND CONSEQUENTIAL DAMAGES

YOUR SOLE AND EXCLUSIVE REMEDY UNDER THIS LIMITED WARRANTY SHALL BE PRODUCT REPAIR AS PROVIDED HEREIN. WHIRLPOOL SHALL NOT BE LIABLE FOR INCIDENTAL OR CONSEQUENTIAL DAMAGES. Some states and provinces do not allow the exclusion or limitation of incidental or consequential damages, so these limitations and exclusions may not apply to you. This warranty gives you specific legal rights, and you also may have other rights that vary from state to state or province to province.

If outside the 50 United States and Canada, contact your authorized Whirlpool dealer to determine if another warranty applies. 7/12

For additional product information, in the U.S.A., visit www.whirlpool.com.

In Canada, visit www.whirlpool.ca.

If you do not have access to the Internet and you need assistance using your product or you would like to schedule service, you may contact Whirlpool at the number below.

Have your complete model number ready. You can find your model number and serial number on the label, located on the inside wall of the refrigerator compartment.

For assistance or service in the U.S.A., call 1-800-253-1301. In Canada, call 1-800-807-6777.

If you need further assistance, you can write to Whirlpool with any questions or concerns at the address below:

In the U.S.A.:

Whirlpool Brand Home Appliances
Customer eXperience Center
553 Benson Road
Benton Harbor, MI 49022-2692

In Canada:

Whirlpool Brand Home Appliances
Customer eXperience Centre
200 - 6750 Century Ave.
Mississauga, Ontario L5N 0B7

Please include a daytime phone number in your correspondence.

Please keep all provided instructions and your model number information for future reference.



INSTRUCTIONS D'UTILISATION DU RÉFRIGÉRATEUR

Nous vous REMERCIONS d'avoir acheté ce produit de haute qualité. Si vous rencontrez un problème non mentionné dans la section DÉPANNAGE ou RÉOLUTION DE PROBLÈMES, veuillez visiter notre site Web www.whirlpool.com pour des informations supplémentaires. Si vous avez toujours besoin d'assistance, veuillez nous téléphoner au 1-800-253-1301. Au Canada, visitez notre site Web www.whirlpool.ca ou téléphonez-nous au 1-800-807-6777.

Vous aurez besoin de vos numéros de modèle et de série situés sur la paroi interne du compartiment de réfrigération.

SÉCURITÉ DU RÉFRIGÉRATEUR

Votre sécurité et celle des autres est très importante.

Nous donnons de nombreux messages de sécurité importants dans ce manuel et sur votre appareil ménager. Assurez-vous de toujours lire tous les messages de sécurité et de vous y conformer.



Voici le symbole d'alerte de sécurité.

Ce symbole d'alerte de sécurité vous signale les dangers potentiels de décès et de blessures graves à vous et à d'autres.

Tous les messages de sécurité suivront le symbole d'alerte de sécurité et le mot "DANGER" ou "AVERTISSEMENT". Ces mots signifient :

⚠ DANGER

Risque possible de décès ou de blessure grave si vous ne suivez pas immédiatement les instructions.

⚠ AVERTISSEMENT

Risque possible de décès ou de blessure grave si vous ne suivez pas les instructions.

Tous les messages de sécurité vous diront quel est le danger potentiel et vous disent comment réduire le risque de blessure et ce qui peut se produire en cas de non-respect des instructions.

IMPORTANTES INSTRUCTIONS DE SÉCURITÉ

AVERTISSEMENT : Pour réduire les risques d'incendie, de choc électrique ou des blessures lors de l'utilisation du réfrigérateur, prendre quelques précautions fondamentales, y compris les suivantes :

- Brancher l'appareil sur une prise à 3 alvéoles reliée à la terre.
- Ne pas enlever la broche de liaison à la terre.
- Ne pas utiliser un adaptateur.
- Ne pas utiliser un câble de rallonge.
- Débrancher la source de courant électrique avant l'entretien.
- Replacer pièces et panneaux avant de faire la remise en marche.
- Enlever les portes de votre vieux réfrigérateur.
- Utiliser un produit de nettoyage ininflammable.
- Garder les matériaux et les vapeurs inflammables, telle que l'essence, loin du réfrigérateur.
- Utiliser deux ou plus de personnes pour déplacer et installer le réfrigérateur.
- Débrancher le réfrigérateur avant l'installation de la machine à glaçons (seulement pour modèles prêts à recevoir une machine à glaçons).
- Utiliser un verre robuste pour prendre des glaçons (sur certains modèles).
- Ne pas heurter les portes en verre du réfrigérateur (sur certains modèles).

CONSERVEZ CES INSTRUCTIONS

INSTALLATION INSTRUCTIONS

Counter Depth Side by Side Refrigerator

IMPORTANT: READ AND SAVE THESE INSTRUCTIONS. INSTALLATION REQUIRES 2 OR MORE PEOPLE.

INSTRUCCIONES DE INSTALACIÓN

Refrigerador de dos puertas con profundidad de mostrador

IMPORTANTE: LEA Y GUARDE ESTAS INSTRUCCIONES. LA INSTALACIÓN REQUIERE DE 2 O MÁS PERSONAS.

INSTRUCTIONS D'INSTALLATION

Réfrigérateur côte à côte à profondeur de comptoir

IMPORTANT : LIRE ET CONSERVER CES INSTRUCTIONS. L'INSTALLATION NÉCESSITE L'INTERVENTION DE 2 PERSONNES OU PLUS.

Table of Contents / Índice / Table des matières

ASSISTANCE OR SERVICE	1	AYUDA O SERVICIO TÉCNICO	12	ASSISTANCE OU SERVICE	24
REFRIGERATOR SAFETY	2	SEGURIDAD DEL REFRIGERADOR	12	SÉCURITÉ DU RÉFRIGÉRATEUR	24
INSTALLATION REQUIREMENTS	2	REQUISITOS DE INSTALACIÓN	12	EXIGENCES D'INSTALLATION	24
Tools and Parts	2	Piezas y herramientas	12	Outillage et pièces.....	24
Product Dimensions.....	2	Medidas del producto.....	13	Dimensions du produit.....	25
Location Requirements.....	4	Requisitos de ubicación.....	15	Exigences d'emplacement	27
Electrical Requirements	5	Requisitos eléctricos.....	15	Spécifications électriques	27
Water Supply Requirements.....	5	Requisitos del suministro de agua.....	16	Spécifications de l'alimentation en eau	28
INSTALLATION INSTRUCTIONS	5	INSTRUCCIONES DE INSTALACIÓN	16	INSTRUCTIONS D'INSTALLATION	28
Unpack the Refrigerator.....	5	Desempaque el refrigerador	16	Déballage du réfrigérateur	28
Custom Door Panels.....	6	Paneles para puerta a la medida	17	Panneaux de porte personnalisés	29
Install New Water Line	8	Cómo instalar la tubería de agua nueva.....	19	Installation d'une nouvelle	
Connect Water Supply	9	Conexión del suministro de agua	20	canalisation d'eau	31
Plug in Refrigerator	10	Cómo enchufar el refrigerador	21	Raccordement de la canalisation d'eau	32
Prepare the Water System.....	10	Preparación del sistema de agua	22	Brancher le réfrigérateur	33
Leveling and Door Closing.....	11	Nivelación y cierre de la puerta.....	22	Préparer le système d'eau	34
Door Alignment	11	Alineamiento de la puerta	23	Nivellement et fermeture de la porte	34
Complete Installation	11	Complete la instalación.....	23	Alignement des portes	35
				Achever l'installation	35

Assistance or Service

If You Have Questions

If you have questions about operating, cleaning or maintaining your refrigerator, see the Use & Care Guide.

If You Need Service

Maintain the quality built into your refrigerator by calling an authorized service company.

To locate an authorized service company, see the Use & Care Guide for the number to call, phone the dealer from whom you purchased the refrigerator, or check the yellow pages of your local phone directory.

Keep this book and your sales slip together for future reference. You must provide proof of purchase or installation date for in-warranty service.

Write down the following information about your appliance to help you obtain assistance or service if you ever need it. You will need to know your complete model number and serial number. You can find this information on the model and serial number label, located on the inside wall of the refrigerator compartment.

Dealer name _____

Serial number _____

Address _____

Phone number _____

Model number _____

Purchase date _____

REFRIGERATOR SAFETY

Your safety and the safety of others are very important.

We have provided many important safety messages in this manual and on your appliance. Always read and obey all safety messages.



This is the safety alert symbol.

This symbol alerts you to potential hazards that can kill or hurt you and others.

All safety messages will follow the safety alert symbol and either the word "DANGER" or "WARNING."

These words mean:

⚠ DANGER

You can be killed or seriously injured if you don't immediately follow instructions.

⚠ WARNING

You can be killed or seriously injured if you don't follow instructions.

All safety messages will tell you what the potential hazard is, tell you how to reduce the chance of injury, and tell you what can happen if the instructions are not followed.

INSTALLATION REQUIREMENTS

Tools and Parts

IMPORTANT:

- Observe all governing codes and ordinances.
- Installer: Leave Installation Instructions with homeowner.
- Homeowner: Keep Installation Instructions for future reference and for the local electrical inspector's use.
- Keep cardboard shipping piece or plywood under refrigerator until it is installed in the operating position.
- Comply with installation specifications and dimensions.
- Remove any moldings or decorative panels from kitchen cabinets that would not allow access to the refrigerator for service.
- Contact a qualified electrical installer.

TOOLS NEEDED (on some models):

Gather the required tools and parts before starting installation. Read and follow the instructions provided with any tools listed here.

- Cordless drill
- 1/4" Nut driver and drill bit
- Flat-blade screwdriver
- 5/16" or adjustable wrench
- 7/16" and 1/2" Open-end wrenches
- Two adjustable wrenches
- 3/8" and 1/2" Socket wrenches

PARTS NEEDED (on some models):

- Your refrigerator dealer has a kit available with a 1/4" (6.35 mm) saddle-type shutoff valve, a union, and copper tubing.
- Or you can purchase a 1/4" (6.35 mm) copper tubing with shutoff valve and a 1/4" (6.35 mm) compression fitting (coupling).
- Depending on water line connections, you may also need a 1/4" (6.35 mm) nut and 1/4" (6.35 mm) ferrule.

Product Dimensions

Top View

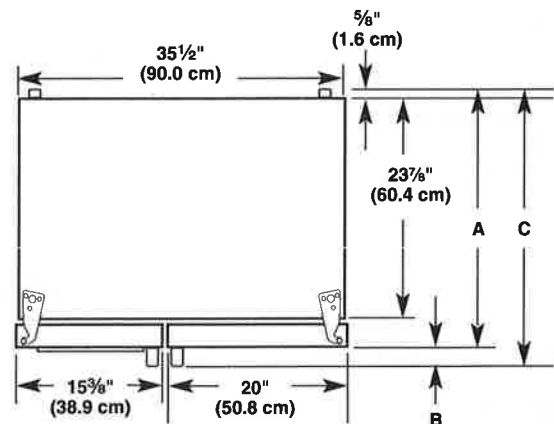

Door Style	Depth A	Depth B	Depth C
Flat	27 1/2" (69.8 cm)	2 5/8" (6.5 cm) maximum*	30" (76.3 cm) maximum*
Curved	28 5/8" (72.5 cm)	2 5/8" (6.5 cm)	31 1/8" (79.1 cm)

*Dimension may vary based on style of door handle. The depth for the largest available handle is listed.

Front View

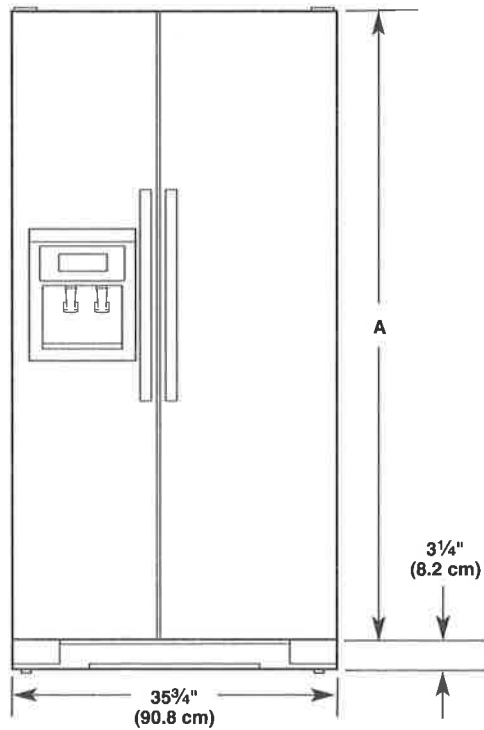

Model Size	Height A
69"	65 3/4" (166.9 cm)
72"	68 1/8" (172.9 cm)

Side View

- Height dimensions are shown with the leveling legs extended to the minimum height of 1/4" (6.35 mm) below the refrigerator.
- **NOTE:** When leveling legs are fully extended to 1" (25 mm) below the refrigerator, add 3/4" (19 mm) to the height dimensions.
- The power cord is 61 1/4" (155.6 cm) long.
- The water line attached to the back of the refrigerator is 78" (198.1 cm) long.

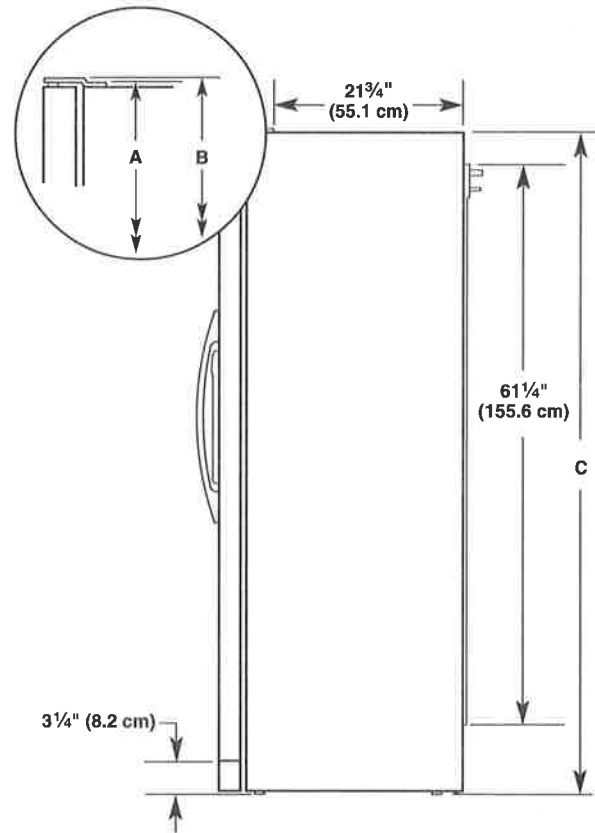

Model Size	Height A	Height B	Height C
69"	68 7/8" (174.8 cm)	68 7/8" (174.9 cm)	68 1/2" (174.2 cm)
72"	71 1/4" (180.8 cm)	71 1/4" (180.9 cm)	71" (180.2 cm)

Opening Dimensions

- Height dimensions are shown with the leveling legs extended to the minimum height of $\frac{1}{4}$ " (6.35 mm) below the refrigerator.
- NOTE:** When leveling legs are fully extended to 1" (25 mm) below the refrigerator, add $\frac{3}{4}$ " (19 mm) to the height dimensions.
- In the following graphic, "A" represents the opening height required for standard cabinets. For full-overlay cabinet doors with a trim kit, add $\frac{1}{8}$ " (0.3 cm).
- In the following graphic, "B" represents the distance needed to fully open the freezer door and "C" represents the distance needed to fully open the refrigerator door.

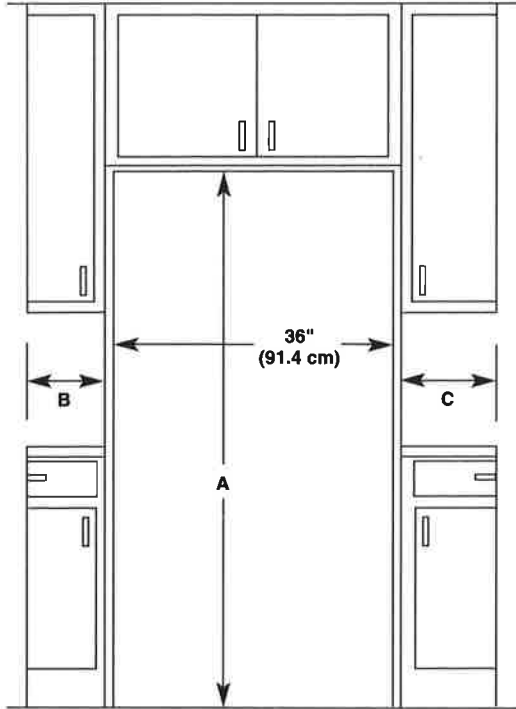

Model Size and Door Style	Height A	Width B	Width C
69" Flat	69" (175.3 cm)	13 $\frac{5}{8}$ " (34.5 cm) maximum*	18 $\frac{1}{8}$ " (46.0 cm) maximum*
72" Flat	72" (182.9 cm)	13 $\frac{5}{8}$ " (34.5 cm) maximum*	18 $\frac{1}{8}$ " (46.0 cm) maximum*
69" Curved	69" (175.3 cm)	13 $\frac{3}{4}$ " (34.9 cm)	18 $\frac{3}{8}$ " (46.4 cm)
72" Curved	72" (182.9 cm)	13 $\frac{3}{4}$ " (34.9 cm)	18 $\frac{3}{8}$ " (46.4 cm)

*Dimension may vary based on style of door handle. The width for the largest available handle is listed.

Door Swing Dimensions

- Location must permit doors to open to a minimum of 165°.
- In the following graphic, "A" represents the distance needed to fully open the freezer door and "B" represents the distance needed to fully open the refrigerator door.

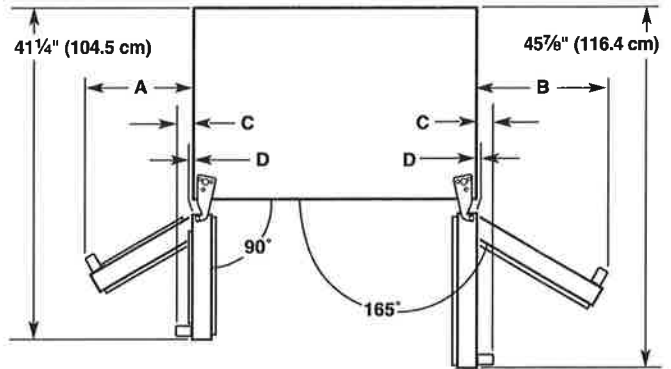

Dimension	Flat Doors	Curved Doors
A	13 $\frac{5}{8}$ " (34.5 cm) maximum*	13 $\frac{3}{4}$ " (34.9 cm)
B	18 $\frac{1}{8}$ " (46.0 cm) maximum*	18 $\frac{3}{8}$ " (46.4 cm)
C	2 $\frac{3}{4}$ " (6.7 cm) maximum*	3 $\frac{3}{4}$ " (9.4 cm)
D	$\frac{1}{8}$ " (0.2 cm)	1 $\frac{1}{4}$ " (2.9 cm)

*Dimension may vary based on style of door handle. The width for the largest available handle is listed.

Location Requirements

⚠ WARNING



Explosion Hazard

Keep flammable materials and vapors, such as gasoline, away from refrigerator.

Failure to do so can result in death, explosion, or fire.

NOTES:

- The cabinet depth refrigerator can be installed into a recessed opening, at the end of cabinets or as a freestanding refrigerator.
- If you are installing the refrigerator to fit flush with the front of the base cabinets, all shoe molding and baseboards must be removed from the rear of the refrigerator opening. Allow for 1" (2.54 cm) of space behind the refrigerator.
- Location should permit doors to open fully. See the "Door Swing Dimensions" section.
- Do not install the refrigerator near an oven, radiator, or other heat source, nor in a location where the temperature will fall below 55°F (13°C).
- Floor must support refrigerator weight (more than 600 lbs [272 kg], door panels and contents).

Electrical Requirements

⚠ WARNING



Electrical Shock Hazard

Plug into a grounded 3 prong outlet.

Do not remove ground prong.

Do not use an adapter.

Do not use an extension cord.

Failure to follow these instructions can result in death, fire, or electrical shock.

Before you move your refrigerator into its final location, it is important to make sure you have the proper electrical connection.

Recommended Grounding Method

A 115 volt, 60 Hz., AC only 15- or 20-amp fused, grounded electrical supply is required. It is recommended that a separate circuit serving only your refrigerator be provided. Use an outlet that cannot be turned off by a switch. Do not use an extension cord.

IMPORTANT: If this product is connected to a GFCI (Ground Fault Circuit Interrupter) protected outlet, nuisance tripping of the power supply may occur, resulting in loss of cooling. Food quality and flavor may be affected. If nuisance tripping has occurred, and if the condition of the food appears poor, dispose of it.

NOTE: Before performing any type of installation, cleaning, or removing a light bulb, turn the control (Thermostat, Refrigerator or Freezer Control depending on the model) to OFF and then disconnect the refrigerator from the electrical source. When you are finished, reconnect the refrigerator to the electrical source and reset the control (Thermostat, Refrigerator or Freezer Control depending on the model) to the desired setting.

Water Supply Requirements

Gather the required tools and parts before starting installation. Read and follow the instructions provided with any tools listed here.

TOOLS NEEDED:

- Flat-blade screwdriver
- 1/4" Nut driver
- 7/16" and 1/2" Open-end or two adjustable wrenches
- 1/4" Drill bit
- Cordless drill

NOTE: Your refrigerator dealer has a kit available with a 1/4" (6.35 mm) saddle-type shutoff valve, a union, and copper tubing. Before purchasing, make sure a saddle-type valve complies with your local plumbing codes. Do not use a piercing-type or 3/16" (4.76 mm) saddle valve which reduces water flow and clogs more easily.

IMPORTANT:

- All installations must meet local plumbing code requirements.
- Use copper tubing and check for leaks. Install copper tubing only in areas where the household temperatures will remain above freezing.

Water Pressure

A cold water supply with water pressure of between 30 and 120 psi (207 and 827 kPa) is required to operate the water dispenser and ice maker. If you have questions about your water pressure, call a licensed, qualified plumber.

Reverse Osmosis Water Supply

IMPORTANT: The pressure of the water supply coming out of a reverse osmosis system going to the water inlet valve of the refrigerator needs to be between 30 and 120 psi (207 and 827 kPa).

If a reverse osmosis water filtration system is connected to your cold water supply, the water pressure to the reverse osmosis system needs to be a minimum of 40 to 60 psi (276 to 414 kPa).

If the water pressure to the reverse osmosis system is less than 40 to 60 psi (276 to 414 kPa):

- Check to see whether the sediment filter in the reverse osmosis system is blocked. Replace the filter if necessary.
- Allow the storage tank on the reverse osmosis system to refill after heavy usage.
- If your refrigerator has a water filter, it may further reduce the water pressure when used in conjunction with a reverse osmosis system. Remove the water filter. See "Water Filtration System" in the Use & Care Guide.

If you have questions about your water pressure, call a licensed, qualified plumber.

INSTALLATION INSTRUCTIONS

Unpack the Refrigerator

⚠ WARNING

Excessive Weight Hazard

Use two or more people to move and install refrigerator.

Failure to do so can result in back or other injury.

Remove the Packaging

Dispose of/recycle all packaging materials. Do not use sharp instruments, rubbing alcohol, flammable fluids, or abrasive cleaners to remove tape or glue. These products can damage the surface of your refrigerator.

IMPORTANT:

- Use 3/8" socket wrench to remove skids.
- All four leveling legs must contact the floor to support and stabilize the full weight of the refrigerator.

When Moving Your Refrigerator:

Your refrigerator is heavy. When moving the refrigerator for cleaning or service, be sure to cover the floor with cardboard or hardboard to avoid floor damage. Always pull the refrigerator straight out when moving it. Do not wiggle or "walk" the refrigerator when trying to move it, as floor damage could occur.

Clean Before Using

After you remove all of the package materials, clean the inside of your refrigerator before using it. See the cleaning instructions in the Use & Care Guide.

Important information to know about glass shelves and covers:

Do not clean glass shelves or covers with warm water when they are cold. Shelves and covers may break if exposed to sudden temperature changes or impact, such as bumping. Tempered glass is designed to shatter into many small, pebble-size pieces. This is normal. Glass shelves and covers are heavy. Use both hands when removing them to avoid dropping.

Custom Door Panels (on some models)

Custom door panels allow you to blend the exterior of your refrigerator into the overall kitchen décor. If you plan to install custom wood panels, you will need to create the panels yourself or consult a qualified cabinetmaker or carpenter. Follow these panel dimension and placement instructions to be sure that the custom panels will fit properly.

The custom panels must have backer panels attached in order to mount them to the refrigerator. It is most common to work with three panels, as shown in the following graphic: a $\frac{3}{4}$ " (19.05 mm) decorative panel, a $\frac{1}{16}$ " (1.59 mm) spacer panel or spacer strips, and a $\frac{1}{4}$ " (6.35 mm) backer panel.

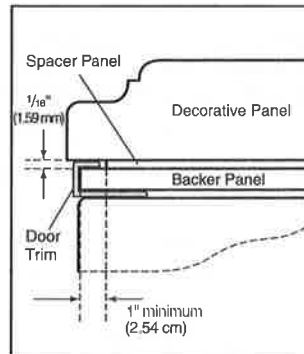
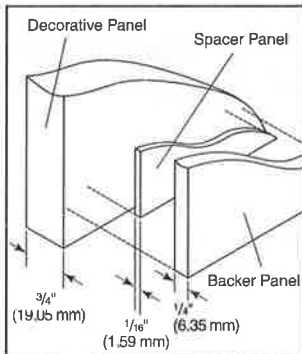

NOTE: You can also work with two panels, as shown in the following graphic: a $\frac{3}{4}$ " (19.05 mm) decorative panel routed with a $\frac{1}{16}$ " (1.59 mm) cutout, and a separate $\frac{1}{4}$ " (6.35 mm) backer panel.

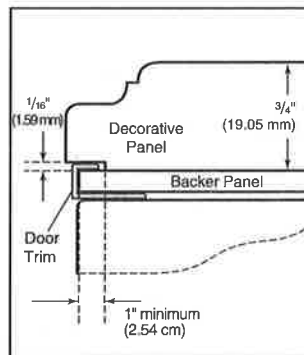
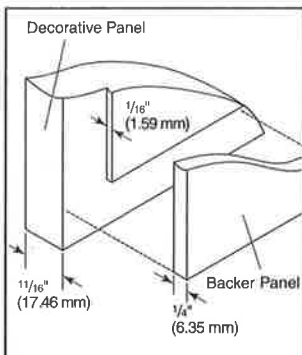

Weight Limits

IMPORTANT: Panels weighing more than the recommended weight may cause damage to your refrigerator.

- The weight of the freezer door panel(s) cannot exceed 25 lbs (11.3 kg).
- The weight of the refrigerator door panel(s) cannot exceed 41 lbs (18.6 kg).

To minimize panel weight, you may use 2" (5.08 cm) spacer strips around the perimeter in place of solid full-sheet spacer panels. The spacer strips must be set in at least 1" (2.54 cm) from the top, bottom and side edges of the backer panel. If you use spacer strips, it is also recommended that you use two horizontally-centered 2" (5.08 cm) strips for added support.

Decorative Panel Dimensions

NOTE: The dashed line represents the placement of the dispenser frame.

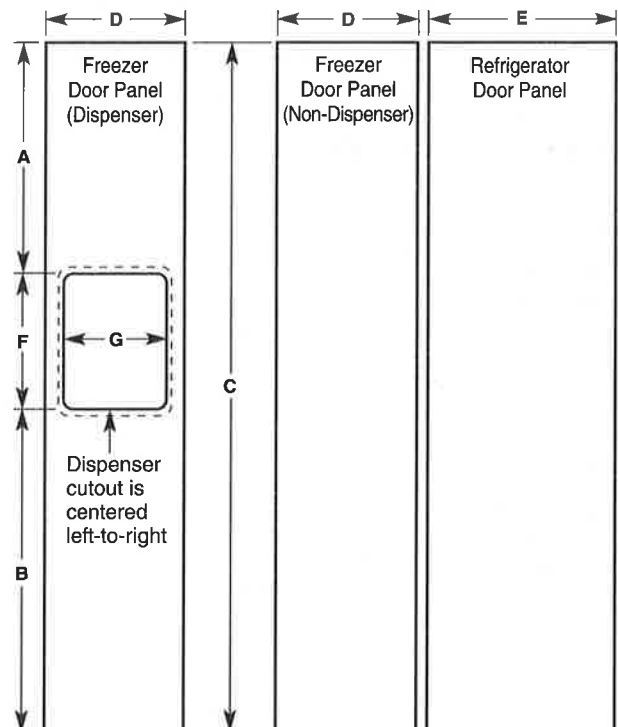

Dimension	Height/Width
A	19 $\frac{3}{8}$ " (49.2 cm)
B	31 $\frac{3}{4}$ " (80.6 cm)
C	68 $\frac{3}{16}$ " (173.2 cm)
D	15 $\frac{3}{8}$ " (39.1 cm)
E	20" (50.8 cm)
F	17 $\frac{1}{16}$ " (43.3 cm)
G	11 $\frac{15}{32}$ " (29.1 cm)

Backer and Spacer Panel Dimensions

NOTE: The dashed lines represent the placement of the backer and spacer panels on the decorative panels. Backer and spacer panels should be centered vertically and horizontally.

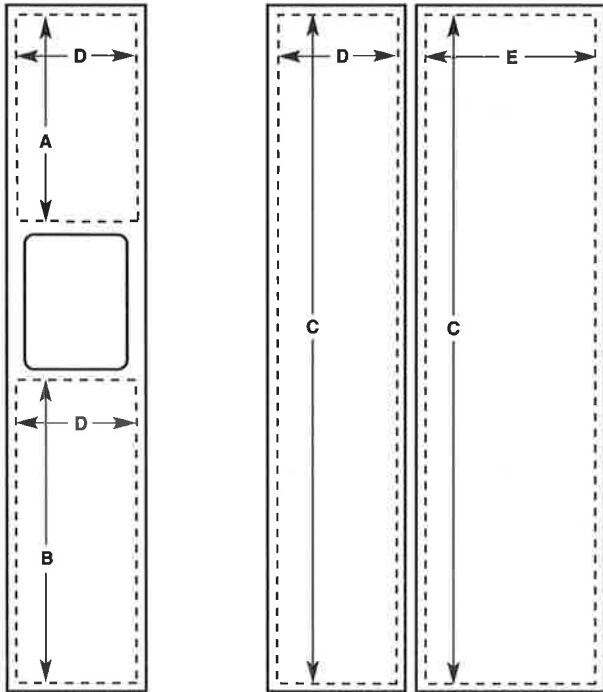

Dimension	Backer Panel	Spacer Panel
A	19" (48.3 cm)	18 $\frac{5}{8}$ " (46.7 cm)
B	31 $\frac{15}{32}$ " (79.9 cm)	30 $\frac{3}{4}$ " (78.1 cm)
C	67 $\frac{29}{32}$ " (172.5 cm)	66 $\frac{9}{16}$ " (169.1 cm)
D	14 $\frac{7}{8}$ " (37.8 cm)	14 $\frac{1}{4}$ " (36.2 cm)
E	19 $\frac{1}{2}$ " (49.6 cm)	18 $\frac{7}{8}$ " (47.9 cm)

Install the Door Panels

NOTE: In the graphics throughout this section, dark gray represents the door trim and light gray represents the door panel.

1. Remove the upper trim from the top of the freezer door.

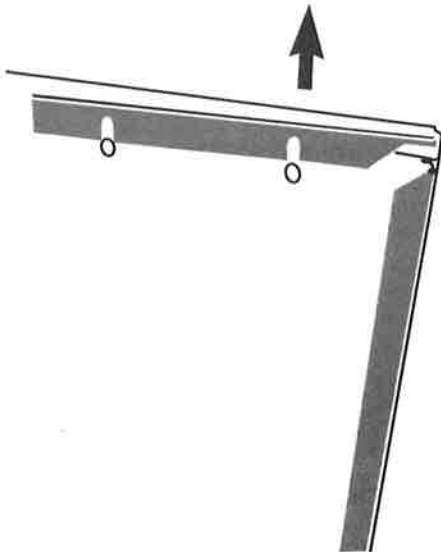

2. Remove the side trim from each side of the freezer door.

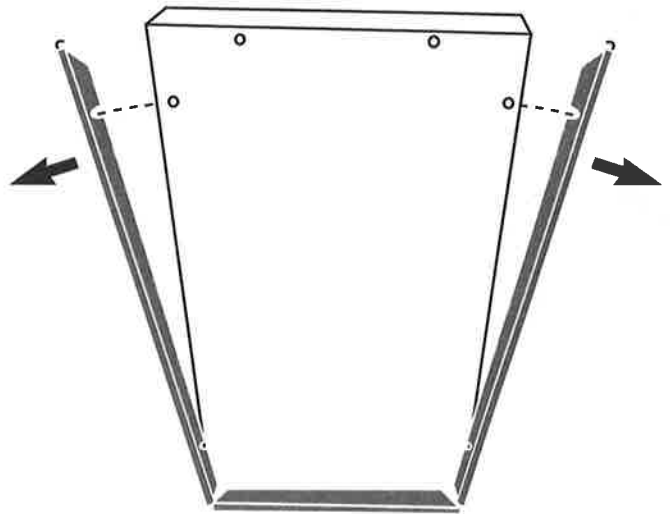

3. Align the bottom edge of the door panel with the lower trim on the bottom of the freezer door. Center the panel on the freezer door.

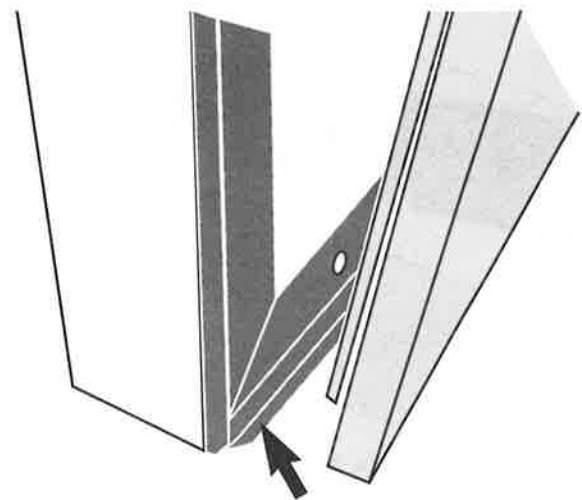

4. Reseat each side trim, making sure the trim clip slides inside the corner of the lower trim.

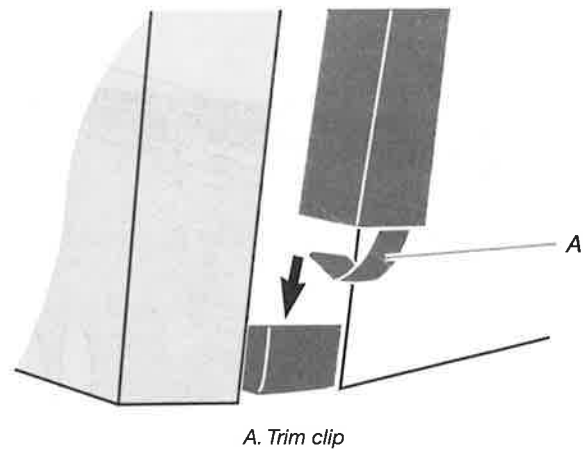

5. With the side trims properly seated in the lower trim, slide each trim into the door panel groove.

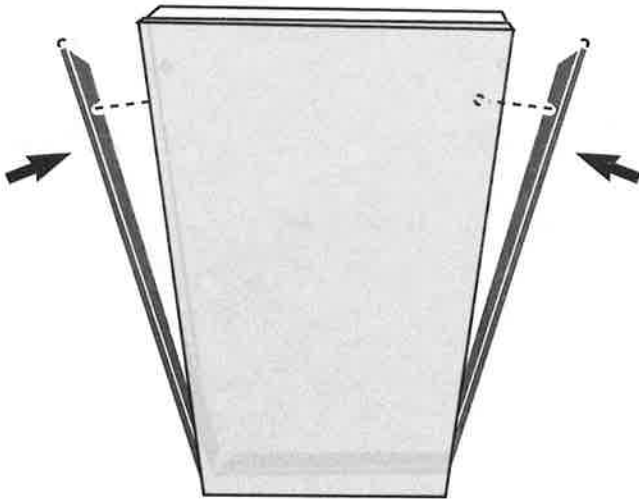

6. Align the upper trim with the trim clips at the top of each side trim.

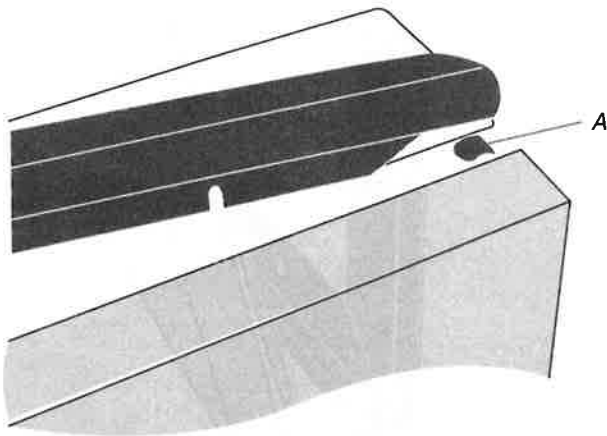

A. Trim clip

7. Slide the upper trim into the door panel groove by applying firm downward pressure. Be sure that the grooves on the upper trim are properly aligned with the rivets on the door panel.

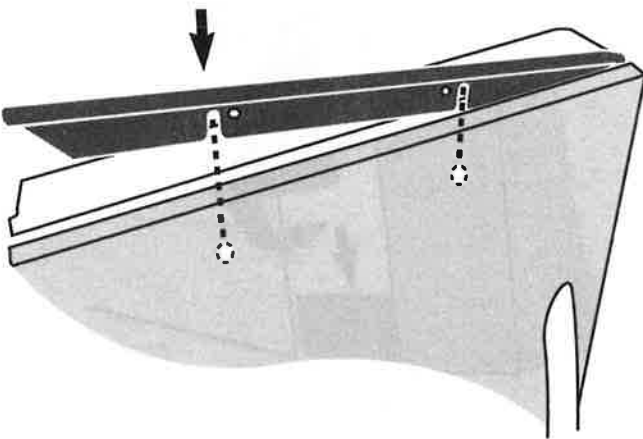

8. When fully seated, the upper trim should be nearly flush with the top of the freezer door, completely covering both side trim clips.

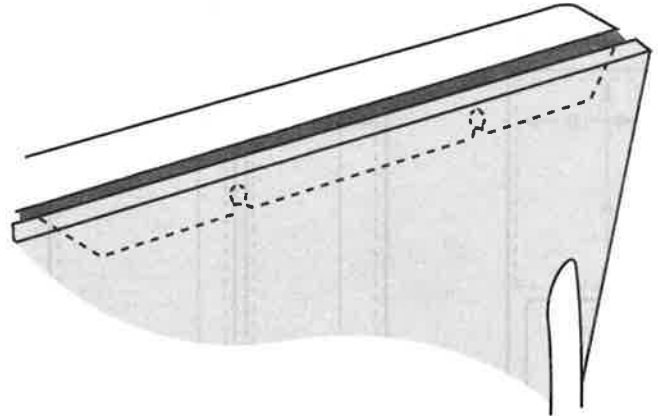

9. Repeat the previous steps to install the refrigerator door panel.

Install Dispenser Frame (dispenser models only)

After installing the custom door panels, snap the dispenser frame onto the freezer door as shown.

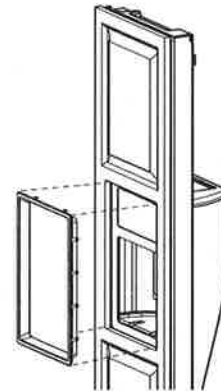

Install New Water Line (if required)

TOOLS NEEDED:

- Flat-blade screwdriver
- 1/4" Drill bit
- 7/16" and 1/2" Open-end or two adjustable wrenches
- Cordless drill

1. Turn OFF main water supply. Turn ON nearest faucet long enough to clear line of water.
2. Find a 1/2" (12.70 mm) to 1 1/4" (3.18 cm) vertical cold water pipe near the refrigerator.

NOTE: Horizontal pipe will work, but the following procedure must be followed:

- Drill on the top side of the pipe, not the bottom. This will help keep water away from the drill. This also keeps normal sediment from collecting in the valve.
3. Determine the length of copper tubing you need. Measure from the connection on the lower left rear of refrigerator to the water pipe. Add 7 ft (2.1 m) to allow for cleaning. Use 1/4" (6.35 mm) O.D. (outside diameter) copper tubing. Be sure both ends of copper tubing are cut square.

- Using a cordless drill, drill a 1/4" (6.35 mm) hole in the cold water pipe you have selected.

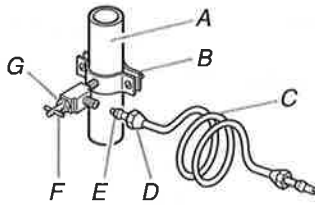

A. Cold water pipe
 B. Pipe clamp
 C. Copper tubing
 D. Compression nut
 E. Compression sleeve
 F. Shutoff valve
 G. Packing nut

- Fasten shutoff valve to cold water pipe with pipe clamp. Be sure outlet end is solidly in the 1/4" (6.35 mm) drilled hole in the water pipe and that washer is under the pipe clamp. Tighten packing nut. Tighten the pipe clamp screws slowly and evenly so washer makes a watertight seal. Do not overtighten or you may crush the copper tubing, especially if soft (coiled) copper tubing is used. Now you are ready to connect the copper tubing.
- Slip compression sleeve and compression nut on copper tubing as shown in the diagram. Insert the end of the tubing into the outlet end of the shutoff valve as far as it will go. Screw the compression nut onto the outlet end with an adjustable wrench. Do not overtighten.
- Place the free end of the tubing into a container or sink, turn ON main water supply and flush out tubing until water is clear. Turn OFF the shutoff valve on the water pipe.

NOTE: To allow sufficient water flow to the refrigerator, a minimum 1/2" size copper household supply line is recommended.

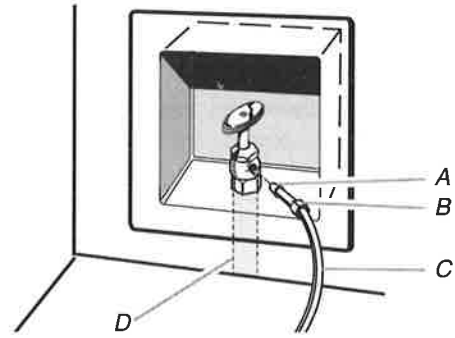

A. Bulb
 B. Nut
 C. Copper tubing (to refrigerator)
 D. Household supply line (1/2" minimum)

- Now you are ready to connect the copper tubing to the shutoff valve. Use 1/4" (6.35 mm) OD soft copper tubing to connect the shutoff valve and the refrigerator.
 - Ensure that you have the proper length needed for the job. Be sure both ends of the copper tubing are cut square.
 - Slip compression sleeve and compression nut onto copper tubing as shown. Insert end of tubing into outlet end squarely as far as it will go. Screw compression nut onto outlet end with adjustable wrench. Do not overtighten.

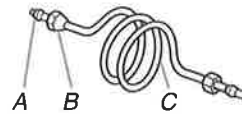

A. Compression sleeve
 B. Compression nut
 C. Copper tubing

- Place the free end of the tubing into a container or sink, and turn on main water supply to flush out tubing until water is clear. Turn off shutoff valve on the water pipe.

NOTE: Always drain the water line before making the final connection to the inlet of the water valve, to avoid possible water valve malfunction.
- Bend the copper tubing to meet the water line inlet, which is located on the back of the refrigerator cabinet as shown. Leave a coil of copper tubing to allow the refrigerator to be pulled out of the cabinet or away from the wall for service.

Connect Water Supply

Read all directions before you begin.

IMPORTANT:

- Plumbing shall be installed in accordance with the International Plumbing Code and any local codes and ordinances.
- Use copper tubing or Whirlpool supply line, Part Number 8212547RP, and check for leaks.
- Install tubing only in areas where temperatures will remain above freezing.

TOOLS NEEDED:

Gather the required tools and parts before starting installation.

- Flat-blade screwdriver
- 7/16" and 1/2" open-end wrenches or two adjustable wrenches
- 1/4" nut driver

Connect to Water Line

IMPORTANT: If you turn the refrigerator on before the water line is connected, turn the ice maker OFF.

- Unplug refrigerator or disconnect power.
- Turn OFF main water supply. Turn ON nearest faucet long enough to clear line of water.
- Use a quarter-turn shutoff valve or the equivalent, served by a 1/2" copper household supply line.

Connect to Refrigerator

Style 1

- Unplug refrigerator or disconnect power.
- Remove and discard the short, black plastic part from the end of the water line inlet.
- Thread the nut onto the end of the tubing. Tighten the nut by hand. Then tighten it with a wrench two more turns. Do not overtighten.

NOTE: To avoid rattling, be sure the copper tubing does not touch the cabinet's side wall or other parts inside the cabinet.

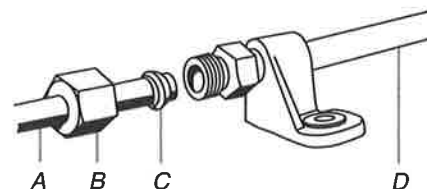

A. Line to refrigerator
 B. Nut (purchased)
 C. Ferrule (purchased)
 D. Supplied line from refrigerator

4. Install the water supply tube clamp around the water supply line to reduce strain on the coupling.
5. Turn shutoff valve ON.
6. Check for leaks. Tighten any connections (including connections at the valve) or nuts that leak.

Style 2

1. Unplug refrigerator or disconnect power.
2. Remove and discard the plastic part that is attached to the inlet of the water valve.
3. Attach the copper tube to the valve inlet using a compression nut and sleeve as shown. Tighten the compression nut. Do not overtighten.
4. Use the tube clamp on the back of the refrigerator to secure the tubing to the refrigerator as shown. This will help avoid damage to the tubing when the refrigerator is pushed back against the wall.
5. Turn shutoff valve ON.
6. Check for leaks. Tighten any connections (including connections at the valve) or nuts that leak.

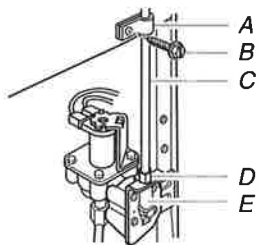

A. Tube clamp
B. Tube clamp screw
C. Copper tubing
D. Compression nut
E. Valve inlet

7. On some models, the ice maker is equipped with a built-in water strainer. If your water conditions require a second water strainer, install it in the 1/4" (6.35 mm) water line at either tube connection. Obtain a water strainer from your nearest appliance dealer.

Style 3

1. Unplug refrigerator or disconnect power.
2. Remove and discard the black nylon plug from the gray water tube on the rear of the refrigerator.
3. If the gray water tube supplied with the refrigerator is not long enough, a 1/4" x 1/4" (6.35 mm x 6.35 mm) coupling is needed in order to connect the water tubing to an existing household water line. Thread the provided nut onto the coupling on the end of the copper tubing.

NOTE: Tighten the nut by hand. Then tighten it with a wrench two more turns. Do not overtighten.

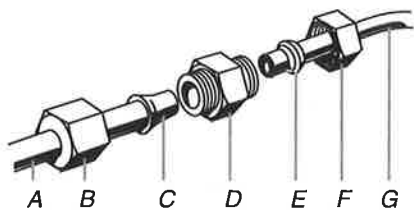

A. Refrigerator water tubing
B. Nut (provided)
C. Bulb
D. Coupling (purchased)
E. Ferrule (purchased)
F. Nut (purchased)
G. Household water line

4. Turn shutoff valve ON.
5. Check for leaks. Tighten any nuts or connections (including connections at the valve) that leak.

Plug in Refrigerator

⚠ WARNING



Electrical Shock Hazard

Plug into a grounded 3 prong outlet.

Do not remove ground prong.

Do not use an adapter.

Do not use an extension cord.

Failure to follow these instructions can result in death, fire, or electrical shock.

1. Plug into a grounded 3 prong outlet.

Prepare the Water System

Please read before using the water system.

Immediately after installation, follow the steps below to make sure that the water system is properly cleaned.

1. Open the freezer door and turn off the ice maker. The On/Off switch can only be accessed when the ice storage bin has been removed. The switch is located on the freezer door, on the left side of the wall that surrounds the ice storage bin. Move the switch to the OFF (right) setting.
2. Make sure the water filter is properly installed.

Do not use with water that is microbiologically unsafe or of unknown quality without adequate disinfection before or after the system. Systems certified for cyst reduction may be used on disinfected waters that may contain filterable cysts.

3. Flush the water system. Use a sturdy container to depress and hold the water dispenser lever for 5 seconds, then release it for 5 seconds. Repeat until water begins to flow. Once water begins to flow, continue depressing and releasing the dispenser lever (5 seconds on, 5 seconds off) until a total of 3 gal. (12 L) has been dispensed. This will flush air from the filter and water dispensing system, and prepare the water filter for use. Additional flushing may be required in some households. As air is cleared from the system, water may spurt out of the dispenser.
4. Open the freezer door and turn on the ice maker. Move the switch to the ON (left) position. See the Use & Care Guide for further instructions on the operation of your ice maker.
 - Allow 24 hours to produce the first batch of ice.
 - Discard the first three batches of ice produced.
 - Depending on your model, you may want to select the maximum ice feature to increase the production of ice.

Leveling and Door Closing

Your refrigerator has two adjustable front feet — one on the right and one on the left. In most cases, the refrigerator should be steady when both feet are touching the floor. If your refrigerator seems unsteady or if you want the doors to close more easily, adjust the refrigerator's tilt using the instructions below:

1. Move the refrigerator into its final location. Open both doors to 90°. Remove the base grille by removing the two screws, then pulling out on the outside corners.

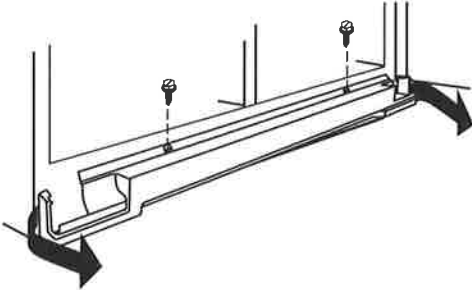

NOTE: The doors must only be opened to 90°. If they are opened all the way, the base grille will not come off.

2. The two leveling feet are located on the brackets on each side of the product.

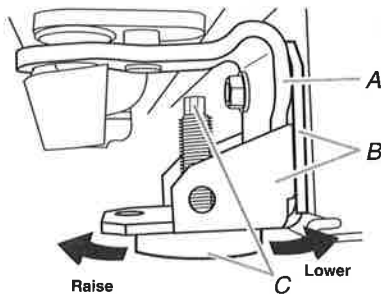

A. Bottom hinge
B. Leveler bracket
C. Leveling foot

NOTE: Having someone push against the top of the refrigerator takes some weight off the leveling feet. This makes it easier to make adjustments.

3. Use a 1/4" open-ended or adjustable wrench to adjust the leveling feet. Turn the leveling foot to the left to raise that side of the product, or turn it to the right to lower that side of the product.
4. Open both doors again and check that they close as easily as you like. If not, tilt the refrigerator slightly more to the rear by turning the leveling feet to the left. It may take several more turns, and you should turn both leveling feet the same amount.

NOTE: Whenever you need to move the refrigerator, turn the leveling feet to the right until they are no longer touching the ground. This will allow the refrigerator to roll more easily.

Door Alignment

A refrigerator that is not level from side-to-side may appear to have doors that are not properly aligned. If the doors appear this way, use the instructions in the previous section to check the leveling.

The doors are designed to be slightly different heights when the refrigerator is empty, in order to account for the weight of food that will be placed on the doors. If the doors are still not aligned after checking the leveling and loading the refrigerator with food, follow the steps below to adjust the door alignment.

1. If necessary, open both doors to 90° and remove the base grille.

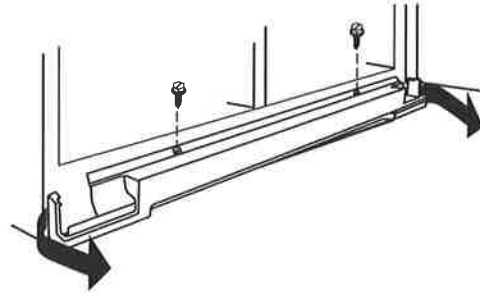

2. Locate the alignment screw on the bottom hinge of the refrigerator door.

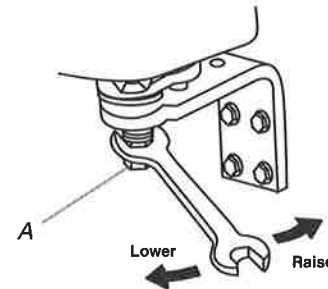

A. Alignment screw

3. Use a 5/16" open-ended or adjustable wrench to turn the screw. To raise the refrigerator door, turn the screw to the right. To lower the door, turn the screw to the left.
4. Check that the doors are even at the top. If necessary, continue to turn the alignment screw until the doors are aligned.
5. Open both doors to 90°. Replace the base grille.

Complete Installation

1. Turn water supply line valve to "Open" position.
2. Turn refrigerator switch to ON position. Wait a few minutes. Check water line connections for leaks.
3. Set refrigerator and freezer compartment controls to the midpoint setting. Check that the compressor is operating properly and that all lights are working.
4. Flush water system before using. See "Prepare the Water System."

NOTE: If construction will continue after refrigerator has been installed, set controls to OFF.

If Refrigerator Does Not Operate

- Check that the circuit breaker is not tripped or household fuse blown.
- Check that the power supply cord is plugged into a grounded 3 prong outlet.
- See "Troubleshooting" in the Use & Care Guide.

INSTRUCCIONES DE INSTALACIÓN

Ayuda o servicio técnico

Si tiene preguntas

Si usted tiene preguntas acerca del funcionamiento, la limpieza o el mantenimiento de su refrigerador, vea el Manual de uso y cuidado.

Si necesita servicio

Para mantener la calidad de su refrigerador, llame a una compañía de servicio autorizada.

Para ubicar una compañía de servicio autorizada, vea el Manual de uso y cuidado para saber a qué número tiene que llamar, llame al distribuidor en donde compró el refrigerador o fíjese en las páginas amarillas de su guía telefónica local.

Guarde este libro y su comprobante de compra juntos para referencia futura. Usted deberá proporcionar evidencia de la compra o una fecha de instalación para obtener servicio bajo la garantía.

Escriba la siguiente información acerca de su electrodoméstico para ayudarlo a obtener asistencia o servicio técnico si alguna vez llegara a necesitarlo. Deberá tener a mano el número completo del modelo y de la serie. Puede encontrar esta información en la etiqueta con el número de modelo y de serie que está ubicada en la pared interior del compartimiento del refrigerador.

Nombre del distribuidor _____

Número de serie _____

Dirección _____

Número de teléfono _____

Número del modelo _____

Fecha de compra _____

SEGURIDAD DEL REFRIGERADOR

Su seguridad y la seguridad de los demás es muy importante.

Hemos incluido muchos mensajes importantes de seguridad en este manual y en su electrodoméstico. Lea y obedezca siempre todos los mensajes de seguridad.



Este es el símbolo de advertencia de seguridad.

Este símbolo le llama la atención sobre peligros potenciales que pueden ocasionar la muerte o una lesión a usted y a los demás.

Todos los mensajes de seguridad irán a continuación del símbolo de advertencia de seguridad y de la palabra "PELIGRO" o "ADVERTENCIA". Estas palabras significan:

⚠ PELIGRO

Si no sigue las instrucciones de inmediato, usted puede morir o sufrir una lesión grave.

⚠ ADVERTENCIA

Si no sigue las instrucciones, usted puede morir o sufrir una lesión grave.

Todos los mensajes de seguridad le dirán el peligro potencial, le dirán cómo reducir las posibilidades de sufrir una lesión y lo que puede suceder si no se siguen las instrucciones.

REQUISITOS DE INSTALACIÓN

Piezas y herramientas

IMPORTANTE:

- Observe todos los códigos y reglamentos aplicables.
- Instalador: Deje las instrucciones de instalación con el propietario.
- Propietario: Guarde las instrucciones de instalación para referencia futura y para que puedan ser usadas por el inspector eléctrico local.
- Mantenga un tramo de cartón de empaque o de madera contrachapada debajo del refrigerador hasta que lo instale en su ubicación final.
- Cumpla con las especificaciones y medidas de instalación.
- Saque todas las molduras o paneles decorativos de los armarios de la cocina que impidan el acceso al refrigerador para darle servicio.
- Contacte a un instalador electricista calificado.