

Pella Info

Service

[servicerequest@pellaboston.com](mailto:servicerequest@pellaboston.com)

David Kean

Service Manager

Pella Windows & Doors

Serving Eastern Massachusetts, Maine and New Hampshire

Cell: 978-423-7038

Phone: 978-420-3146

Fax: 978-373-7274

[Keandm@pellaboston.com](mailto:Keandm@pellaboston.com)

Rebecca ~~Qu~~ (Becky)

Service Coordinator

Pella Windows & Doors

Serving Eastern Massachusetts, Maine and New Hampshire

Phone: 800-866-9886 x 148

Tom Orth |

Service Technician

[800-866-9886](tel:800-866-9886) Ext 3

978-423-9791

Was onsite for installation



# FULL FRAME REMOVAL WHEN PREPARING TO INSTALL A NEW NAIL FIN ENTRY DOOR

This method of Full Frame Removal involves removing the sash and entire frame of the existing door from the wall. The resulting opening is the original rough opening. The existing door nailing fins are usually nailed to the studs in frame construction with siding, brick veneer or other exterior material applied over the fin on the outside. The interior may have a drywall return from the wall to the door frame.

**CAUTION:** Many doors in older homes are painted with lead-based paint. Removal of old doors may disturb this paint. Proper precautions must be taken to minimize exposure to dust and debris. Consult state or local authorities for more information and/or go to [www.epa.gov/lead](http://www.epa.gov/lead) for more information.

## TOOLS REQUIRED:

- Utility knife 
- Phillips and Standard screwdrivers 

- Pry bar 
- Circular saw 

- Hammer 
- Putty knife 

REMEMBER TO USE APPROPRIATE PERSONAL PROTECTIVE EQUIPMENT.

## EXISTING WOOD BRICKMOULD FRAME DOOR

- Score paint or varnish between the interior trim and the wall with a sharp utility knife.

*Note: This will minimize the damage to the interior wall and trim.*

- Remove the interior trim. Using a pry bar and block of wood, remove the interior trim from all four sides of the door including the stool at the bottom of the door. If the interior trim is being reused, pull the nails out through the back side of the board with nipper pliers.

- Cut the exterior sealant line between the exterior brickmould or trim and the exterior siding or wall cladding.

- Remove the panels (if necessary) to make the door lighter.

- Remove the exterior brickmould or flat trim using a pry bar and block of wood.  
*Caution: Some doors may come out of the opening as the exterior trim is removed.*

- Remove the door frame using a pry bar if necessary.

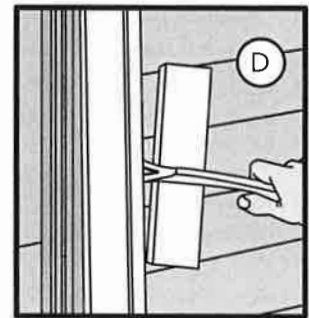
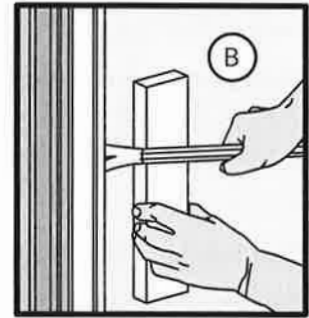

## EXISTING NAIL FIN DOOR REMOVAL

### PANEL REMOVAL

- Remove the panels (if necessary) to make the door lighter.

### DOOR WITH EXTERIOR TRIM

- Remove the existing exterior trim (if applicable). Use a block of wood to protect the exterior wall material. Use a pry bar to remove the existing exterior trim.
- Remove the nails or screws attaching the door nailing fin to the wall.
- Remove the door from the opening.

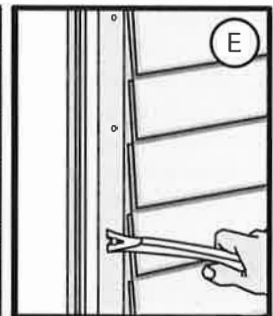
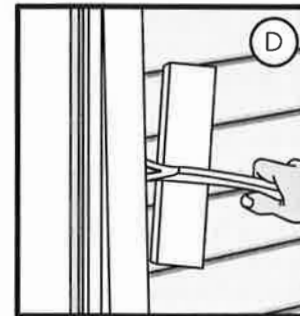

### DOOR WITH NO EXTERIOR TRIM

- Use a reciprocating saw to cut through sealant line and the nailing fin.  
OR
- Remove siding or cut back the siding a minimum of 3" or far enough to expose the nailing fin. Remove the fasteners attaching the door to the wall.  
*Note: When cutting back the siding, set the saw blade depth 1/8" less than the thickness of the siding. Break the cut ends of the siding off after sawing. DO NOT cut through the existing building wrap.*
- Remove the door from the wall.

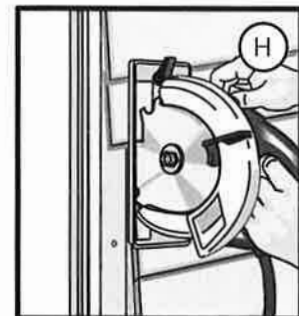

Consult with local providers and authorities to recycle or properly dispose of old door components.



# PREPARING FOR HINGED ENTRY DOOR INSTALLATION WITH NAIL FIN

## YOU WILL NEED TO SUPPLY:

- Moisture resistant shims/spacers (12 to 20)
- 1-1/2" galvanized roofing nails (1/4 lb.)
- #10 x 3-1/2" corrosion resistant wood screws (Performance Upgrade & HurricaneShield)
- Masonry screws for concrete applications (Minimum of 3/16" diameter x 3")
- Closed cell foam backer rod/sealant backer (21 to 30 ft.)
- Pella® SmartFlash™ foil backed butyl window and door flashing tape or equivalent
- Pella window and door Installation Sealant or equivalent high quality, multi-purpose sealant.
- Low Expansion, low pressure polyurethane insulating window and door foam sealant. DO NOT use high pressure or latex foams
- Sill pan (optional) 6-5/8" x (Rough Opening Width +2)
- Pella aluminum sill support or wood blocking
- Interior trim and/or jamb extensions (15 to 40 ft.)



## INSTALLATION CLIP OPTION:

- 6" or 8" installation clips
- #6 x 5/8" corrosion resistant flat head wood screws
- #8 x 1-1/2" corrosion resistant screws or 3/16" x 1-1/2" masonry screws



## TOOLS REQUIRED:

- Tape measure
- Level
- Square
- Hammer
- Stapler
- Sealant Gun
- Scissors or utility knife
- Tin Snips
- Screwdrivers (#2 Phillips with 8" shaft and small flat blade)
- T20 Torx Wrench
- Drill
- Drill Bits 13/64" and 1/8" and masonry bit for concrete applications



INSTALLATION WILL REQUIRE (2) OR MORE PERSONS FOR SAFETY REASONS.

Store doors in upright position, out of direct sunlight.

## ROUGH OPENING VERIFICATION

### A. Confirm the opening is plumb and level.

*Note: It is critical the bottom is level and it does not slope to the interior or exterior.*

### B. Remove dirt, oil or debris from the opening and surrounding wall surfaces.

### C. Confirm the door will fit the opening. Measure all four sides of the opening to make sure it is 1/2" to 3/4" larger than the door in both width and 1/2" larger in height. Measure the width and height in several places to ensure the header or studs are not bowed.

*Note: 1-1/2" or more of solid wood blocking is required around the perimeter of the opening. Fix any problems with the rough opening before proceeding.*

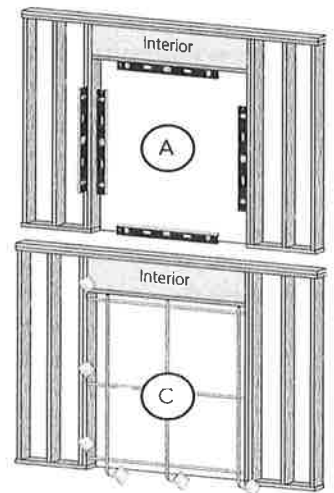

## PREPARE THE DOOR FOR INSTALLATION

### A. Remove plastic wrap and cardboard packaging from the door. DO NOT open the door until it is securely fastened. DO NOT cut the strap that goes from the lock holes to the sill of the door (if applicable).

### B. Inspect the product for any damage such as cracks, dents or scratches. DO NOT install damaged products.

### C. Fold out installation fin to 90° (units with fold up fin only).

Be careful not to remove or tear the fin corners.

*Note: If the fin is not at 90°, the door will not line up correctly on the interior.*

### D. Curved Units with Fins: Install clips on wood with non-structural flex fins or pre-drill holes for frame screws. See nail fin anchor instructions at the end of this booklet.

Units with wide EnduraClad Exterior trim and narrow fins with NO pre-punched holes: Install clips or pre-drill holes for frame screws.

See nail fin anchor instruction at the end of this booklet.

Additional preparation may be required for performance upgrade, impact resistant products or to comply with local building code requirements. See advanced performance or hurricane shield anchor schedule.

### E. Read the entire instruction before proceeding.

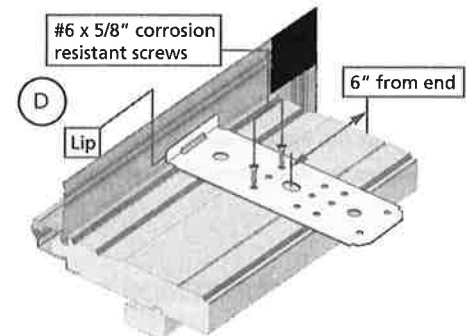
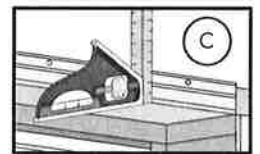

These instructions were developed and tested for use with wall systems designed to manage water. *These instructions are not to be used with any other construction methods or door frame types.* Installation instructions for use with other construction methods or frame types may be obtained from Pella® Corporation, your local Pella retailer or [www.installpella.com](http://www.installpella.com). Building designs, construction methods, building materials, and site conditions unique to your project may require an installation method different from these instructions and/or additional care. Determining the appropriate installation method is the responsibility of you, your architect, or construction professional.



Always read the Limited Warranty before purchasing or installing Pella® products. By installing this product, you are acknowledging that this Limited Warranty is part of the terms of the sale. Failure to comply with all Pella installation and maintenance instructions may void your Pella product warranty. See written Limited Warranty for details, including exceptions and limitations at [pella.com/warranty](http://pella.com/warranty), or contact Pella Customer Service at 877-473-5527.



# NEW CONSTRUCTION INSTALLATION WITH NAIL FIN AFTER BUILDING WRAP

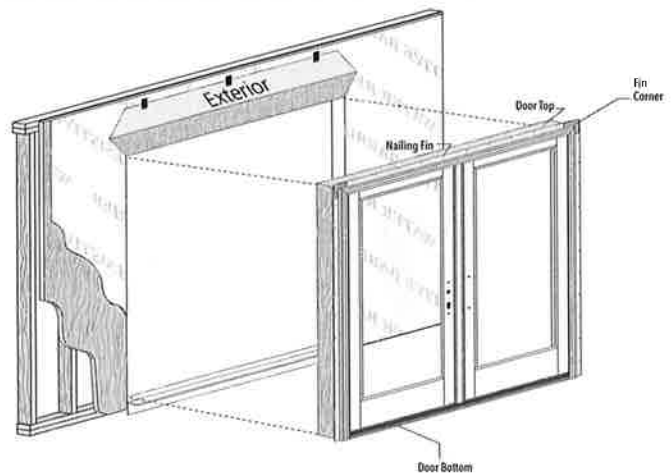
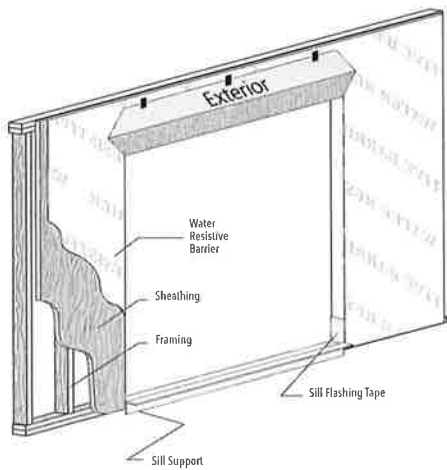

## 1 PREPARE THE OPENING

Refer to the nail fin installation preparation section at the beginning of this booklet.

### A. Cut the building wrap.

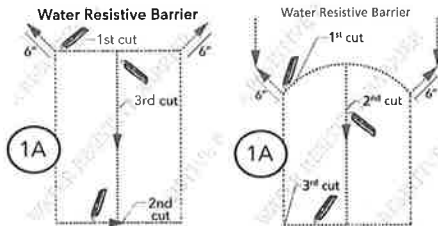

### B. Fold the building wrap in at the jambs and staple it in place. Fold the top flap up and temporarily fasten with flashing tape.

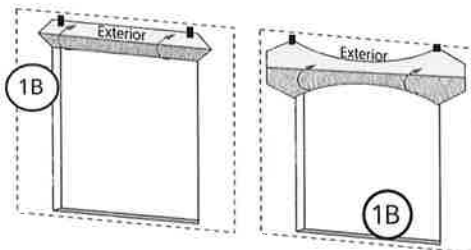

If using an optional sill pan, refer to the sill pan instruction page at the end of this booklet.

### C. Cut 2 pieces of flashing tape 12" longer than opening width.

### D. Apply sill flashing tape #1 at the sill extending 1" to the exterior and 6" up each jamb.

### E. Cut 1" wide tabs at each corner by tearing the foil 1/2" each way from corner.

### F. Apply sill flashing tape #2 overlapping tape #1 by 1" minimum.

**Note: For In-Swing Doors with frame depth greater than 5", add a third piece of flashing tape so it comes within 1/4" of the interior of the door frame.**

**Note: Press all tape down firmly.**

### G. Attach a Pella aluminum sill support or wood blocking flush with the opening sill.

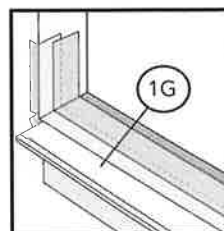
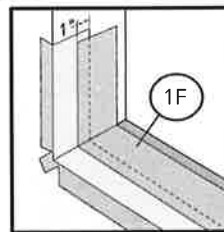
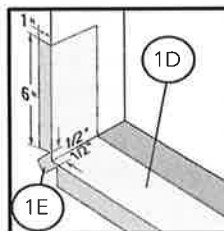

## 2 SETTING AND FASTENING THE DOOR

- A. Place three 3/8" beads of sealant across the opening sill. Place the interior-most bead 1/2" from where the interior of the door sill will remain after installation. Continue this bead 6" up each jamb. Place a second bead 1/2" from the exterior of the framing. Place a 3rd bead in the groove of the sill support or 1/4" from the exterior edge of the wood blocking.

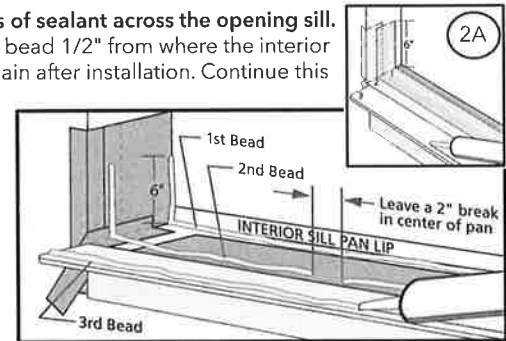

- B. Center the bottom of the door in the opening and tilt the door into position. Do not slide the door into the opening. Sliding will damage the sealant lines. **Check the hinge jambs for plumb and confirm there is room for shimming between the jambs and opening on each side.**

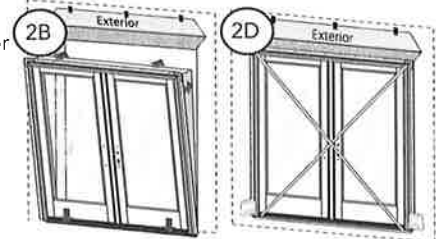

- C. Drive two fasteners, one near each end of the top nailing fin. (See nail fin anchor instructions at the end of this booklet)
- D. Plumb and square the door. Place shims at each hinge and lock strike. Keep shims 1/2" short of door frame depth. Insert additional shims starting 6" from the bottom as needed to keep jambs straight and panel reveals even on all four sides.

**Note: Additional shims are required at screw locations for advanced performance, impact resistant units and combinations. See the nail fin anchor instructions at the end of this booklet.**

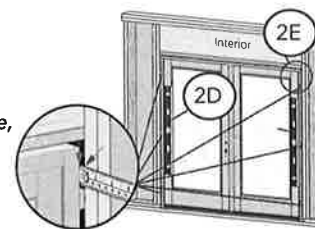

- E. Check the door placement by measuring from the interior surface of the door frame or jamb extension to the interior surface of the wall for consistency. If the dimensions are not equal, confirm the fins are folded fully to 90° (if applicable).
- F. Finish driving fasteners into the nailing fin. Refer to the nail fin anchor instructions at the end of this booklet.
- G. Check door operation.

Carefully open the door(s) and remove the shipping spacers (check under the door panel(s)). Use the construction handle to operate the panel(s). To operate flushbolts, see the instruction label on the astragal strike (if applicable).

**Note: Adjust shims to correct any issues with plumb, square, operation or reveal.**

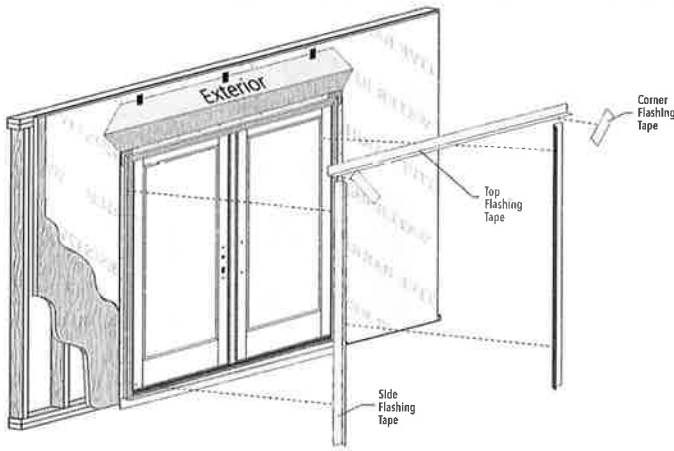

## 2 SETTING AND FASTENING THE DOOR (CONTINUED)

- H. Pre-drill and drive screws at hinges, head and sill strikes or jamb strikes, threshold or low-profile sill and frames. See the nail fin anchor instructions at the end of this booklet.
- I. Open and close the door to check operation. Make sure the door will latch correctly. If there are problems with operation adjust the shims and hinges (see below) and confirm the door frame is plumb, level and square and the gap between the door panel(s) and frame is consistent.
- J. Adjustable hinges can be used to move the panel(s). Turn the center screw with a T20 Torx wrench clockwise (+) to move the panel away from the frame or counter-clockwise (-) to move the panel toward the frame. A 3/4 turn provides approximately 5/32" adjustment.

Do not adjust the hinges if the top and bottom hinge screws are loose.

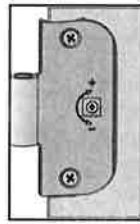

Adjustable Hinge

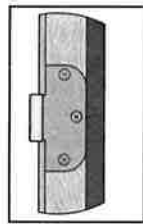

Non-Adjustable Hinge

- K. Doors without adjustable hinges have plastic shims behind the hinges; remove shims to move the panel toward the frame. Additional shims may be added to move the panel away from the frame.

## 3 INTEGRATING WITH THE BUILDING WRAP

Note: Apply flashing tape 1/2" onto frame cladding with fold-up or slide-in fins. Pre-fold flashing tape at 1/2" to assist with application. For siding less than 1/2" thick, adjust the placement of the tape to allow the exterior sealant to cover the tape edge.

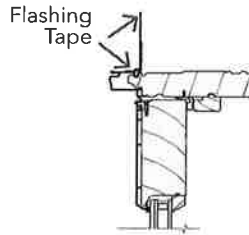

- A. Apply straight side flashing tape. Cut two pieces of flashing tape 4" taller than straight sides. Apply tape over the fin and onto weather resistive barrier. Extend tape 2" above and below straight sides.

Doors with angle top transoms or curved tops: On the short side, do not allow the side tape to extend higher than what the top tape will cover.

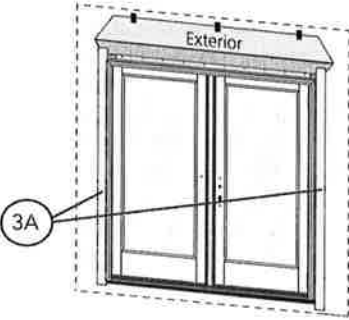

3A

- B. Apply top flashing tape.

Rectangular Units: Cut one piece of flashing tape to extend 1" past both side flashing tapes.

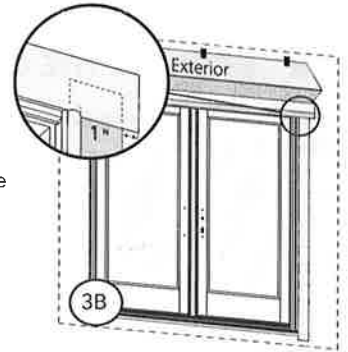

3B

Curved Top Units: Using several short pieces, start taping from the sides of the door working towards the peak. Cut each piece short enough so each piece overlaps the previous piece. Tighter curved frames will require shorter pieces of tape.

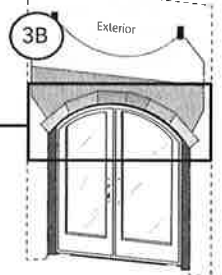
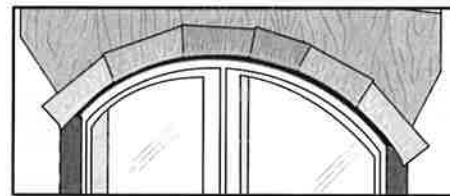

3B

- C. Fold down top flap of weather resistive barrier.
- D. Apply flashing tape to top diagonal cuts. Cut pieces of flashing tape at least 1" longer than each diagonal cut. Lap tape 1" past end of cut onto weather barrier. Overlap multiple pieces of tape by 1" when necessary.

Note: PRESS ALL FLASHING TAPE DOWN FIRMLY.

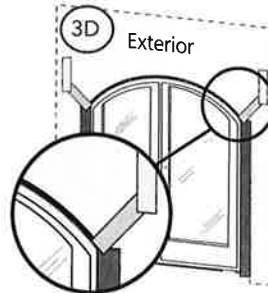

3D

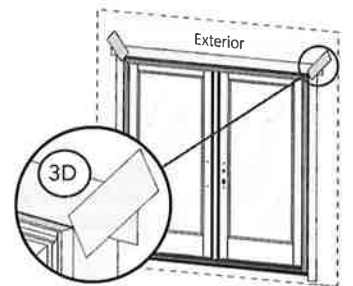

3D

- E. Install interior sealant. Refer to the interior sealant instructions at the end of this booklet.
- F. Install head flashing, properly incorporating it with the siding and building wrap according to applicable code requirements.
- G. Install exterior sealant. (After wall cladding is installed) Refer to the exterior sealant instructions at the end of this booklet.



# ANCHOR INSTRUCTIONS – NAIL FIN INSTALLATION METHODS FOR CLAD EXTERIOR ARCHITECT SERIES® AND PELLA® BRANDED ENTRY DOORS

Note: Standard performance only. Additional anchoring may be required for performance upgrade, impact resistant products or to comply with local building code requirements.

Anchor Location	Venting	Anchor Type		Instructions	Illustration	
		Wood	Masonry			
Head and Jamb Nail Fin	Any	1-1/2" 11 Ga. Roofing Nail	NA	Every pre-punched hole		
Head	Frame	Fixed or Vent	#8 x 3" corrosion resistant (provided)	For Doors with no head strike, Place 1 screw in each pre-drilled hole (if present).		
	Frame	Door/Sidelight Combinations	#10 x 3" corrosion resistant	3/16" Masonry Screw	Pre-drill and install screws 3" and 6" on each side of each mullion end.	H
	Strike	Active/Inactive	(2) #12 x 2-1/2" corrosion resistant (provided)		Remove temporary head strike screw(s). Shim between the frame and rough opening.	A
Jambs	Hinges	In-Swing and Out-Swing	#8 x 3" corrosion resistant (provided)			B
	Strike	Vent	#8 x 3" (provided)		Shim between the frame and rough opening at each strike and deadbolt.	D, E
	Frame	1-Panel vent	#8 x 3" (provided)		Pre-drill and install screw 8" below the top of the lock jamb.	G
Sill	Threshold	Door/Sidelight Combinations	#10 x 3" corrosion resistant	3/16" Masonry Screw	Pre-drill and install screws 3" and 6" on each side of each mullion end.	H
	Strike	Active/Inactive	(2) #12 x 2-1/2" stainless steel (provided)		Remove temporary sill strike screw(s) and place a dab of sealant in each hole before installing the new screws.	A
	Low-Profile	Vent	#8 x 3" corrosion resistant (provided)	3/16" x 3" Masonry Screw	For doors with standard locks, install tubs per instruction included with sill strike package	C

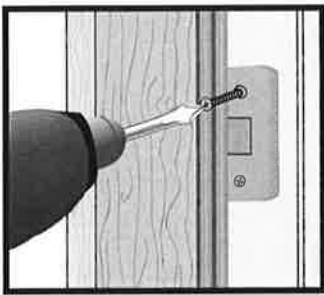
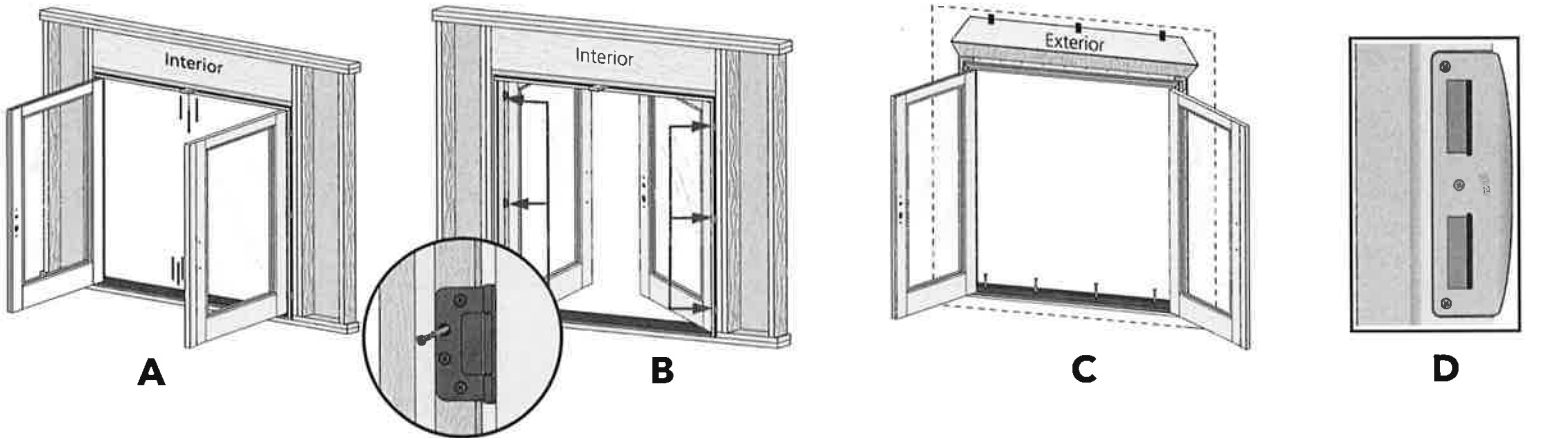

Entry Door

E

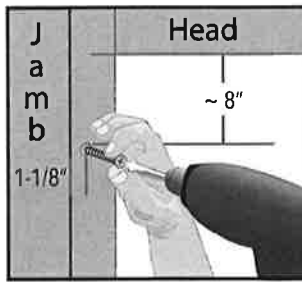

G

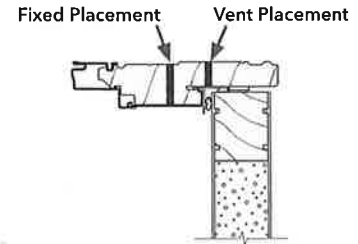
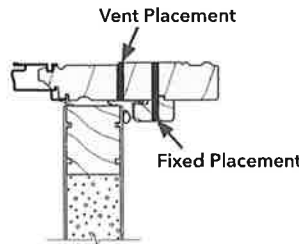

H

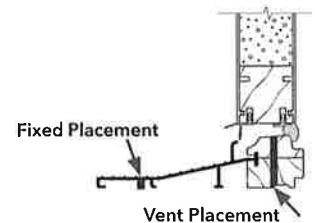
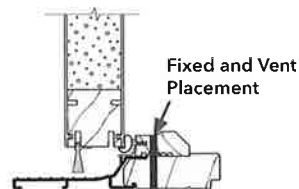

Out-Swing Screw Locations

In-Swing Screw Locations



# ANCHOR INSTRUCTIONS – ARCHITECT SERIES® AND PELLA® BRANDED ENTRY DOORS WITH WIDE ENDURACLAD® EXTERIOR TRIM, NARROW FINNS AND NO PRE-PUNCHED HOLES

*Note: Standard performance only. Additional anchoring may be required for performance upgrade, impact resistant products or to comply with local building code requirements.*

*Units with narrow fins and NO pre-punched holes must be anchored using frame screws or installation clips. These fins are for flashing purposes only.*

Anchor Location	Venting	Anchor Type		Instructions	Illustration	
		Wood	Masonry			
Head	Frame	Fixed or Vent	#8 x 3" corrosion resistant (provided)		For Doors with no head strike, Place 1 screw in each pre-drilled hole (if present).	
	Frame-Screws	Fixed or Vent	#10 x 3-1/2" corrosion resistant	3/16" x 3" Masonry Screw	See Illustrations for spacing and placement.	H, I
	Frame-Clips	Fixed or Vent	(2) #8 x 1-1/4" corrosion Resistant	3/16" x 1-1/2" Masonry Screw	See illustrations for spacing, secure clip to frame using (2) #6 x 5/8" corrosion resistant screws	I, K
	Frame	Door/Sidelight Combinations	#10 x 3" corrosion resistant	3/16" Masonry Screw	Pre-drill and install screws 3" and 6" on each side of each mullion end.	H
	Strike	Active/Inactive	(2) #12 x 2-1/2" corrosion resistant (provided)		Remove temporary head strike screw(s). Shim between the frame and rough opening.	A
Jambs	Hinges	In-Swing and Out-Swing	#8 x 3" corrosion resistant (provided)			B
	Strike	Vent	#8 x 3" (provided)		Shim between each frame and rough opening at the strike and deadbolt.	D, E
	Frame-Screws	Fixed or Vent	#10 x 3-1/2" corrosion resistant	3/16" x 3" Masonry Screw	See Illustrations for spacing and placement. The weatherstrip may be temporarily moved to hide the frame screw.	H, I, J
	Frame-Clips	Fixed or Vent	(2) #8 x 1-1/4" corrosion Resistant	3/16" x 1-1/2" Masonry Screw	See illustrations for spacing, secure clip to frame using (2) #6 x 5/8" corrosion resistant screws	I, K
	1-Panel Frame	Vent	#8 x 3" (provided)		Pre-drill and install screw 8" below the top of the lock jamb.	G
Sill	Threshold	Door/Sidelight Combinations	#10 x 3" corrosion resistant	3/16" Masonry Screw	Pre-drill and install screws 3" and 6" on each side of each mullion end.	H
	Strike	Active/Inactive	(2) #12 x 2-1/2" stainless steel (provided)		Remove temporary sill strike screw(s) and place a dab of sealant in each hole before installing the new screws.	A
	Frame-Screws	Fixed or Vent	#10 x 3-1/2" corrosion resistant	3/16" x 3" Masonry Screw	See Illustrations for spacing and placement.	H, I
	Low-Profile	Vent	#8 x 3" corrosion resistant(provided)	3/16" x 3" Masonry Screw	For doors with standard locks, install tubs per instruction included with sill strike package	C

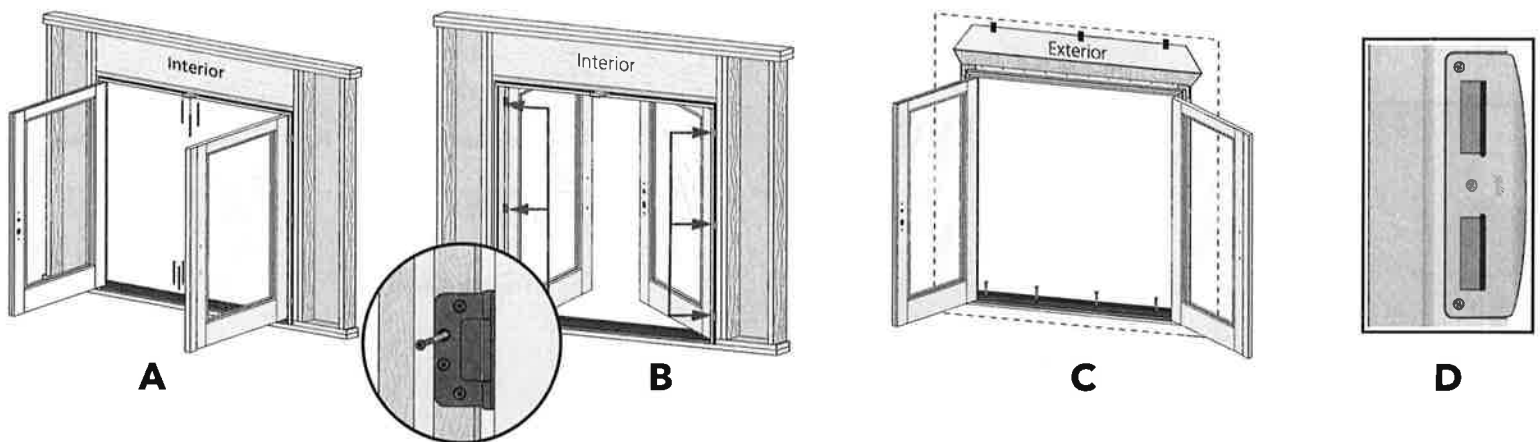

**ILLUSTRATIONS CONTINUED ON NEXT PAGE**



# ANCHOR INSTRUCTIONS – ARCHITECT SERIES® AND PELLA® BRANDED ENTRY DOORS WITH WIDE ENDURACLAD® EXTERIOR TRIM, NARROW FINNS AND NO PRE-PUNCHED HOLES

*Note: Standard performance only. Additional anchoring may be required for performance upgrade, impact resistant products or to comply with local building code requirements.*

*Units with narrow fins and NO pre-punched holes must be anchored using frame screws or installation clips. These fins are for flashing purposes only.*

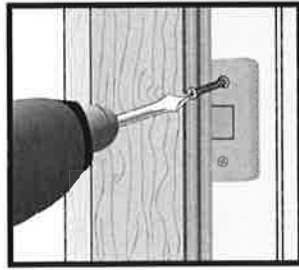

**E**

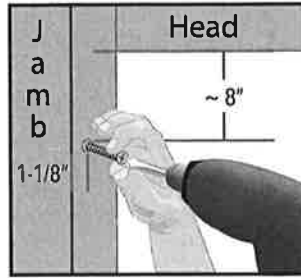

**G**

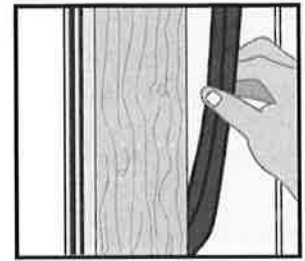

**J**

DOUBLE OPERABLE

SINGLE FIXED OR OPERABLE

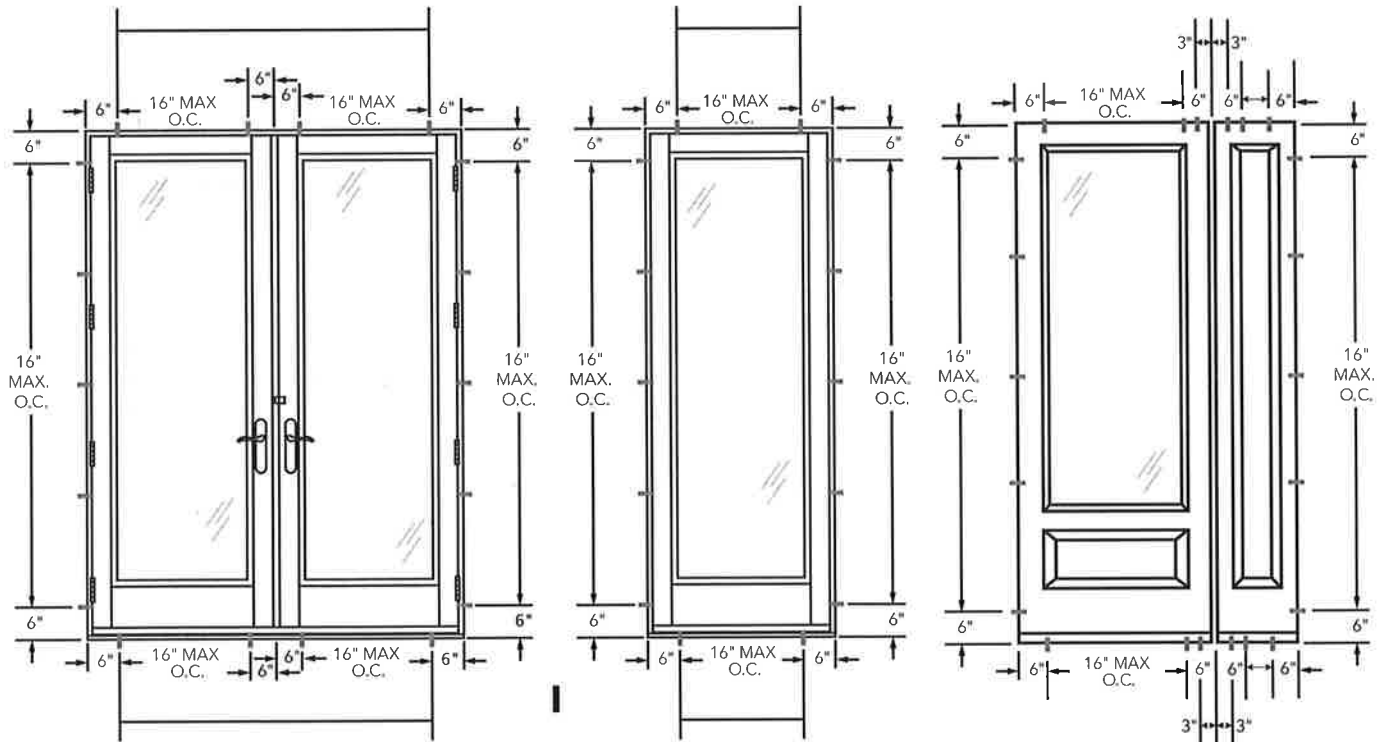

**I**

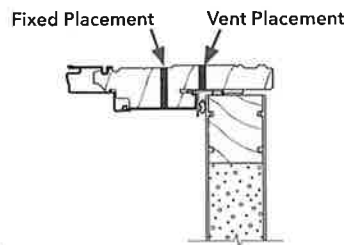
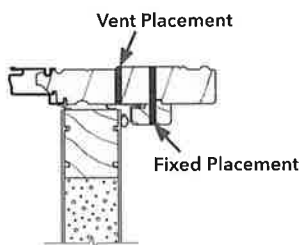

**H**

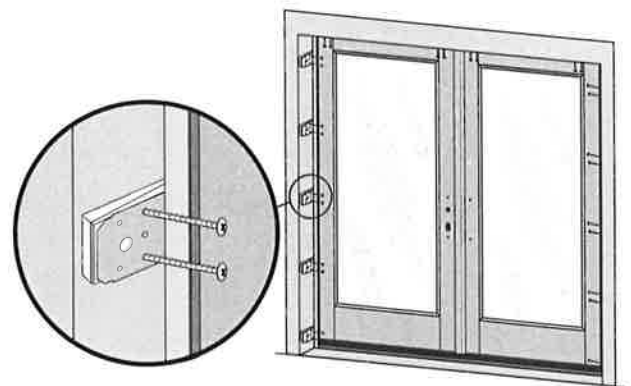
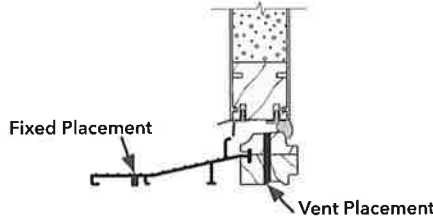
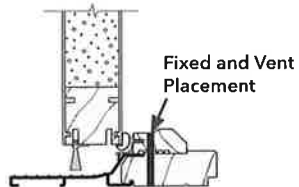

**K**

Out-Swing Screw Locations

In-Swing Screw Locations



## Interior Sealant Instructions

**CAUTION:** Use low pressure polyurethane window and door insulating foams. Follow the directions on the can. Do not use high pressure or latex foams.

- A. Insert the nozzle or straw between the rough opening and door frame from the interior. Use a pliers (if necessary) to compress the end of a straw tube to allow it to fit in tight openings.
  - B. Place a 1" deep bead of foam approximately 1" from the interior of the frame to allow for expansion. DO NOT fill the entire depth of the rough opening cavity.
- Note:** Apply foam between the frame and rough opening, NOT between jamb extensions and the rough opening.
- C. To ensure a continuous interior seal, apply sealant over the interior surface of any shims or clips interrupting the foam seal. Backer rod (as necessary) and sealant can be used in place of the low expansion foam to create the interior seal. However, foam has greater insulating properties. Fiberglass batt or similar insulation is not recommended as it can absorb water and does not act as an air seal.
  - D. Place a continuous bead of sealant across the inner sill at the intersection of the door sill and subfloor. Continue the sealant 6" up each jamb.

**Note:** Use a low odor, paintable sealant such as Pella Window and Door Installation Sealant.

Re-check door operation after foam installation. Excess foam may be removed with a serrated knife after it cures.

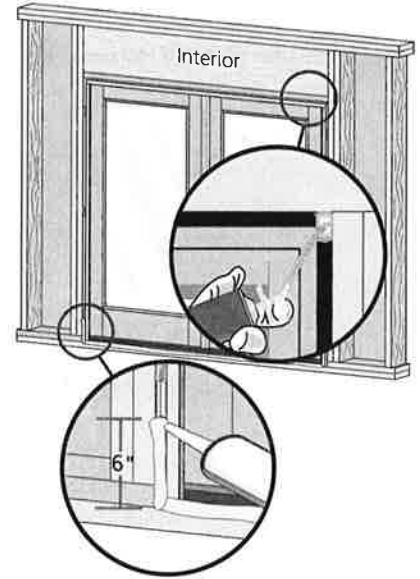

## Exterior Sealant Instructions

**CAUTION:** Use a high quality, multi-purpose exterior sealant such as Pella Window and Door Installation Sealant. Follow the directions on the cartridge.

When applying siding, brick veneer, flashing, or other exterior finish materials, leave adequate space between the door frame and the material for sealant application of sealant.

- A. Insert backer rod 3/8" deep in the space around the door. Backer rod adds shape and controls the depth of the sealant line.
- B. Apply a continuous bead of sealant to the entire perimeter of the door.
- C. Shape, tool and clean excess sealant. When finished, the sealant should be the shape of an hourglass.

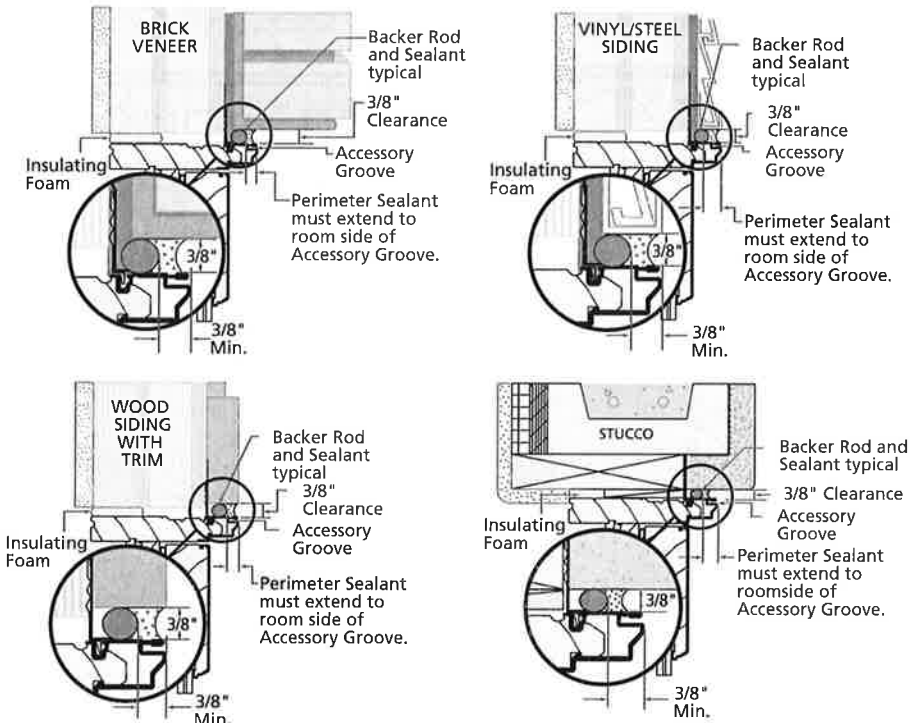
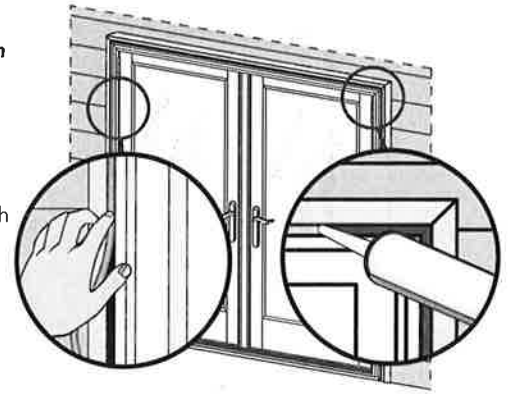



## CARE AND MAINTENANCE

### CLEANING INSTRUCTIONS

**GLASS:** Remove any protective film and labels and clean the glass, using a soft, clean, grit-free cloth and mild soap or detergent. Be sure to remove all liquid by wiping dry or use a clean squeegee.

**FACTORY FINISHED PANELS:** A door panel that has been prefinished with stain or paint from the factory requires no additional finishing. Clean the surface with mild soap and water. DO NOT use abrasives. DO NOT scrape or use tools that might damage the surface.

**PELLA ALUMINUM CLAD FRAMES:** The exterior frame is protected by aluminum cladding with our tough EnduraClad® baked-on-factory finish that needs no painting. Clean this surface with mild soap and water. DO NOT use abrasives. DO NOT scrape or use tools that might damage the surface.

### FINISHING INSTRUCTIONS

Paint or finish immediately after installation.

**Note:** To maintain proper product performance do not paint, finish or remove the weatherstripping, mohair dust pads, gaskets or vinyl parts. Air and water leakage will result if these parts are removed. After finishing, allow venting doors and doors to dry completely before closing them. If paint, stain or finish gets on the weather stripping, wipe it off immediately with a damp cloth

Pella Corporation is not responsible for interior paint and stain finish imperfections for any product that is not factory-applied by Pella Corporation.

**PANEL CLEANING AND PREP INSTRUCTIONS FOR UNFINISHED OR PRIMED PANELS:** Dry wipe dust from doors gently. Examine door for possible smudges or fingerprints made from normal handling or construction. To remove smudges, lightly wipe surface with warm water. DO NOT sand surface of fiberglass panel. Scuff sand with light grade sand paper or abrasive pad (220 grit or higher). Rinse surface with mineral spirits for fiberglass panels and warm water for steel panels. Let door and sidelight surfaces dry completely before applying finish. Finish the door panels as soon as possible after installation.

**STAINING FIBERGLASS PANELS OR UNFINISHED INTERIOR FRAME MEMBERS:** Fiberglass door and sidelight panels may be stained with a gel stain if a wood look is desired. Pella offers stain kits in a variety of colors. Apply and finish per the stain kit manufacturer's instruction. Ensure that all exposed panel edges are finished to minimize the chance of damage. Unprimed interior frame parts may be stained with wood stains and should be finished with a minimum of two coats of a clear polyurethane finish. DO NOT bridge the top coat between the outer edge of the glazing frame and the door panel.

**Note:** The fiberglass base color tone will vary. This variance is normal and will not impact the stain color of the door.

**PAINTING INSTRUCTIONS:** Wood door frame exteriors, premium steel door panels and sidelights are factory primed. Wood doors require painting immediately after installation. The factory applied primer is not intended for long term exterior exposure. Sand all un-primed interior wood surfaces lightly with 180 grit or finer sandpaper before priming and painting. Fiberglass door and sidelight panels do not require priming. Use two coats of a 100% latex paint that has a good blocking resistance. On units with glass, do not bridge paint between the outer edges of the glazing frame and the door panel. On fiberglass products, brush the paint in the same direction as the simulated wood grain. For entry doors, ensure that all exposed panel edges are finished to minimize the chance of panel damage. Finishing panel edges is optional for Patio Doors.

For additional information on finishing see the Pella Owner's Manual or go to [www.pella.com](http://www.pella.com).

The use of unapproved finishes, solvents or cleaning chemicals may cause adverse reactions with door materials. Pella will not be responsible for problems caused by the use of unapproved materials. If in doubt, contact your local retailer or representative.

## CARE AND MAINTENANCE

Care and maintenance information is available by contacting your local Pella retailer. This information is also available at [www.pella.com](http://www.pella.com).

### IMPORTANT NOTICE

Because all construction must anticipate some water infiltration, it is important that the wall system be designed and constructed to properly manage moisture. Pella Corporation is not responsible for claims or damages caused by anticipated and unanticipated water infiltration; deficiencies in building design, construction and maintenance; failure to install Pella products in accordance with Pella's installation instructions; or the use of Pella products in wall systems which do not allow for proper management of moisture within the wall systems. The determination of the suitability of all building components, including the use of Pella products, as well as the design and installation of flashing and sealing systems are the responsibility of the Buyer or User, the architect, contractor, installer, or other construction professional and are not the responsibility of Pella. Pella products should not be used in barrier wall systems which do not allow for proper management of moisture within the wall systems, such as barrier Exterior Insulation and Finish Systems (EIFS) (also known as synthetic stucco) or other non-water managed systems. Except in the states of California, New Mexico, Arizona, Nevada, Utah and Colorado, Pella makes no warranty of any kind on and assumes no responsibility for Pella doors and doors installed in barrier wall systems. In the states listed above, the installation of Pella Products in barrier wall or similar systems must be in accordance with Pella's installation instructions. Product modifications that are not approved by Pella Corporation will void the warranty.



# OPTIONAL SILL PAN INSTRUCTIONS

- A. **Cut the sill pan** to the width of the rough opening plus 2".  
*Note: The 2" added onto the rough opening width is for a 1" bend on each end.*
- B. **Make a 1" cut** in each fold at both end of the sill pan.  
*Note: These cuts will allow the edges of the sill pan to be bent.*  
*Note: 4-5/8" wide for Out-Swing and In-Swing for 4-9/16" wall condition. For other wall conditions, measure wall depth and add 1/16".*
- C. **Cut 1" off** each end of the interior sill pan lip.
- D. **Bend each end** of the center panel up.

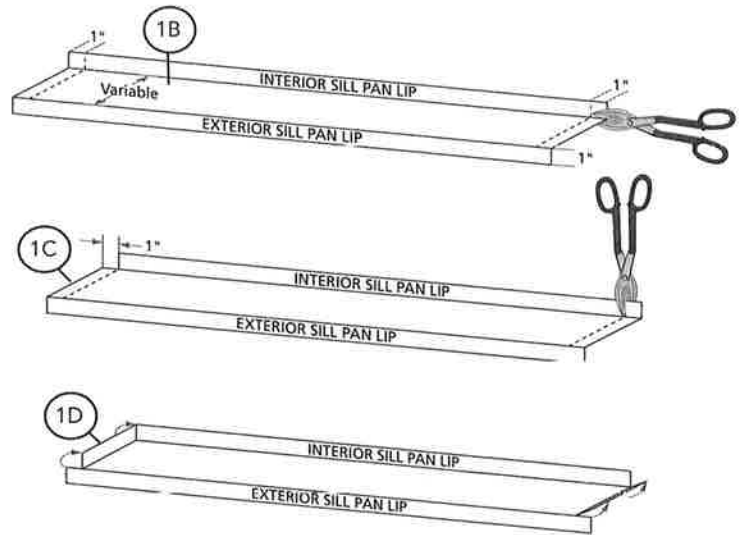

- E. **Install the sill pan** by sliding into place until the exterior sill pan lip is flush with the exterior of the rough opening.
- F. **Apply sill flashing tape.** Cut a piece of flashing tape 2" longer than the opening width. Apply at the bottom of the opening, covering the exterior sill pan lip as shown.  
*Note: If applicable, apply spray adhesive to building felt prior to applying the flashing tape.*

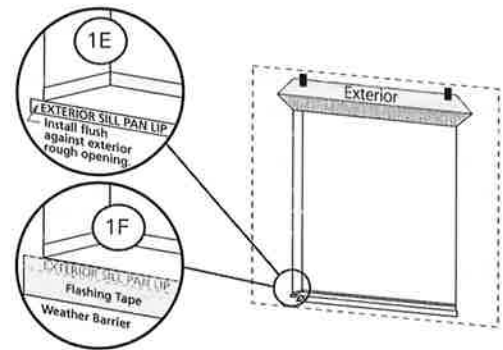

- G. **Cut a piece of flashing tape** to the width of the opening. Install tape to the sill pan and overlap the flashing tape from step 1F by 1". If needed add a second or third piece of flashing tape until the sill pan is covered to the interior sill pan lip.  
*Note: The purpose of this tape is to seal the sill screws when installing the door.*
- H. **Cut two 9" pieces of flashing tape** with a 1" x 3" tab at the bottom, on opposite corners as shown.

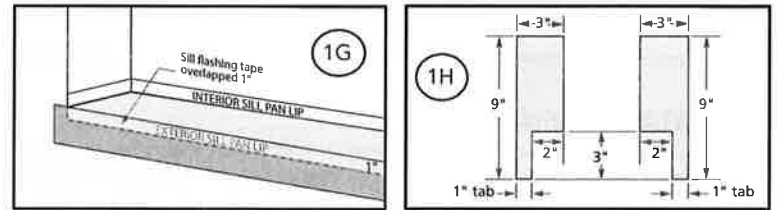

- I. **Apply the tabbed 9" pieces of flashing tape.** The tape is applied so 2" will cover the inside of the rough opening and lap over the side flange of the sill pan. The 1" x 3" tab laps over the bottom flashing tape as shown.
- J. **Cut two 6" pieces of flashing tape** and apply to each side of the rough opening, overlapping the first piece by 1" and lapping the bottom over the side flange of the sill pan as shown.

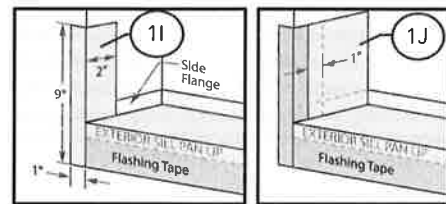

- K. **Cut two pieces of flashing tape 1-1/2" x 6"** and apply to the bottom corners of the opening by beginning in the corner of the sill pan, with 3/4" of the tape applied to the sill pan and 3/4" of the tape applied to the side flange. The remainder of the tape is to be at a 45 degree angle onto the exterior.

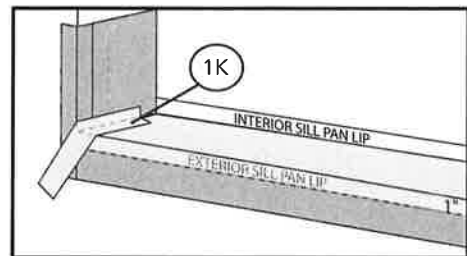

- L. **Attach the aluminum sill support** or wood blocking to the exterior of the

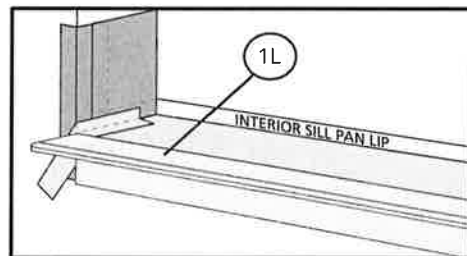

box plate to support the edge of the door sill. Place the sill support flush with the subfloor.