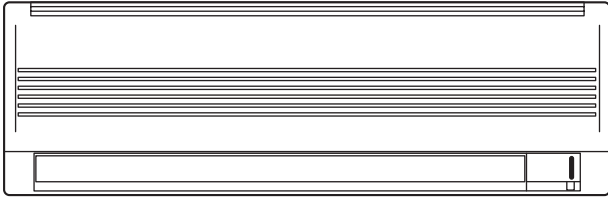


## Operating Instructions Split System Air Conditioner

---



**Model No.**

**Indoor Units**

**CS-MKE18NKU**

**CS-MKE24NKU**

**Outdoor Units**

**CU-3KE19NBU**

**CU-4KE24NBU**

**CU-4KE31NBU**

This air conditioner uses the refrigerant R410A.



Before operating the unit, read these operating instructions thoroughly and keep them for future reference.

# FEATURES

This air conditioner is an inverter type unit that automatically adjusts capability as appropriate. Details on these functions are provided below; refer to these descriptions when using the air conditioner.

- **Microprocessor Controlled Operation**  
The interior compartment of the remote controller contains several features to facilitate automatic operation, easily displayed for easy use.
- **Simple One-touch Remote Controller**  
The remote controller has several features to facilitate automatic operation.
- **24-Hour ON or OFF Timer**  
This timer can be set to automatically turn the unit on or off at any time within a 24 hour period.
- **1-Hour OFF Timer**  
This timer can be set to automatically turn off the unit at any time after one hour.
- **Night Setback**  
This function saves energy by controlling operation to provide a quieter operating sound than normal.
- **Automatic and 3-step Fan Speed**  
Auto/High/Medium/Low
- **Air Sweep Control**  
This function moves a flap up and down in the air outlet, directing air in a sweeping motion around the room and providing comfort in every corner.
- **Auto. Flap Control**  
This automatically sets the flap to the optimum position during heating, cooling, and drying operation.
- **Hot Start Heating System**  
Right from the start, the air is warm and comfortable. This system prevents any cold blasts at the beginning while the heat pump is warming up, or even defrosting.
- **Automatic Restart Function for Power Failure**  
Even when power failure occurs, preset programmed operation can be reactivated once power resumes.
- **High Power Operation**  
If not in Auto Operation, the unit operates at maximum output for 30 minutes, regardless of the desired temperature.  
The fan speed is 1 step above "High".
- **Quiet Operation**  
The fan rotates slower than the fan speed setting to provide a quieter operating sound.

# CONTENTS

	Page		Page
FEATURES.....	2	SPECIAL REMARKS .....	17
PRODUCT INFORMATION .....	2	SETTING THE TIMER .....	18
SAFETY PRECAUTIONS.....	2	USING THE 1-HOUR OFF TIMER .....	20
INSTALLATION LOCATION.....	3	TIPS FOR ENERGY SAVING .....	20
ELECTRICAL REQUIREMENTS .....	3	ADJUSTING THE AIRFLOW DIRECTION .....	21
SAFETY INSTRUCTIONS.....	3	OPERATION WITHOUT THE REMOTE CONTROLLER.....	22
NAMES OF PARTS .....	5	CARE AND CLEANING .....	22
USING THE REMOTE CONTROLLER .....	10	WIRED REMOTE CONTROLLER .....	24
OPERATION WITH THE REMOTE CONTROLLER.....	12	TROUBLESHOOTING (BEFORE CALLING FOR SERVICE) .....	25
1. Automatic Operation .....	12	OPERATING RANGE.....	25
2. Manual Operation.....	13	SPECIFICATIONS.....	26
3. Adjusting the Fan Speed.....	14		
4. Night Setback Mode.....	15		
5. QUIET Mode .....	16		
6. HIGH POWER Mode.....	16		

# PRODUCT INFORMATION

If you have problems or questions concerning your Air Conditioner, you will need the following information. Model and serial numbers are on the nameplate on the bottom of the cabinet.

Model No. \_\_\_\_\_

Serial No. \_\_\_\_\_

Date of purchase \_\_\_\_\_

Dealer's address \_\_\_\_\_

Phone number \_\_\_\_\_

# SAFETY PRECAUTIONS

The following symbols used in this manual, alert you to potentially dangerous conditions to users, service personnel or the appliance:



**WARNING**

This symbol refers to a hazard or unsafe practice which can result in severe personal injury or death.



**CAUTION**

This symbol refers to a hazard or unsafe practice which can result in personal injury or product or property damage.

---

## INSTALLATION LOCATION

- We recommend that this air conditioner be installed properly by qualified installation technicians in accordance with the Installation Instructions provided with the unit.
- Before installation, check that the voltage of the electric supply in your home or office is the same as the voltage shown on the nameplate.



### WARNING

- Do not install this air conditioner where there are fumes or flammable gases, or in an extremely humid space such as a greenhouse.
- Do not install the air conditioner where excessively high heat-generating objects are placed.

EG

**Avoid:** To protect the air conditioner from heavy corrosion, avoid installing the outdoor unit where salty sea water can splash directly onto it or in sulphurous air near a spa.

---

## ELECTRICAL REQUIREMENTS

1. All wiring must conform to the local electrical codes. Consult your dealer or a qualified electrician for details.
2. Each unit must be properly grounded with a ground (or earth) wire or through the supply wiring.
3. Wiring must be done by a qualified electrician.

### NOTE

Pull off the power plug from a receptacle, or switch off the breaker, or switch off the power disconnecting mean to isolate the air conditioner from the main power supply when not in use for a long time.

---

## SAFETY INSTRUCTIONS



- Read this Instruction Manual carefully before using this air conditioner. If you still have any difficulties or problems, consult your dealer for help.
- This air conditioner is designed to give you comfortable room conditions. Use this only for its intended purpose as described in this Instruction Manual.








### WARNING

- Confirm to authorized dealer or specialist on usage of specified refrigerant type. Using of refrigerant other than the specified type may cause product damage, burst and injury etc.
- Never touch the unit with wet hands.
- Never use or store gasoline or other flammable vapor or liquid near the air conditioner — it is very dangerous.
- Do not use this appliance in a potentially explosive atmosphere.
- This air conditioner has no ventilator for intaking fresh air from outdoors. You must open doors or windows frequently when you use gas or oil heating appliances in the same room, which consume a lot of oxygen from the air. Otherwise there is a risk of suffocation in an extreme case.
- Do not swallow the battery.
- After removing the battery from remote controller, keep it away from the reach of children. The battery can cause death by suffocation if swallowed.
- When inserting the battery, make sure the polarities (+ and -) are correct.

**WARNING**

- To prevent possible hazards from insulation failure, the unit must be grounded. 
- Do not clean inside the indoor and outdoor units by users. Engage authorized dealer or specialist for cleaning.
- In case of malfunction of this appliance, do not repair by yourself. Contact to the sales dealer or service dealer for a repair.
- Refrigerant gas leakage may cause fire.
- For safety, be sure to turn the air conditioner off and also to disconnect the power before cleaning. 
- Pull off the power plug from a receptacle, or switch off the breaker, or switch off the power disconnecting mean to isolate the air conditioner from the main power supply in case of emergency.

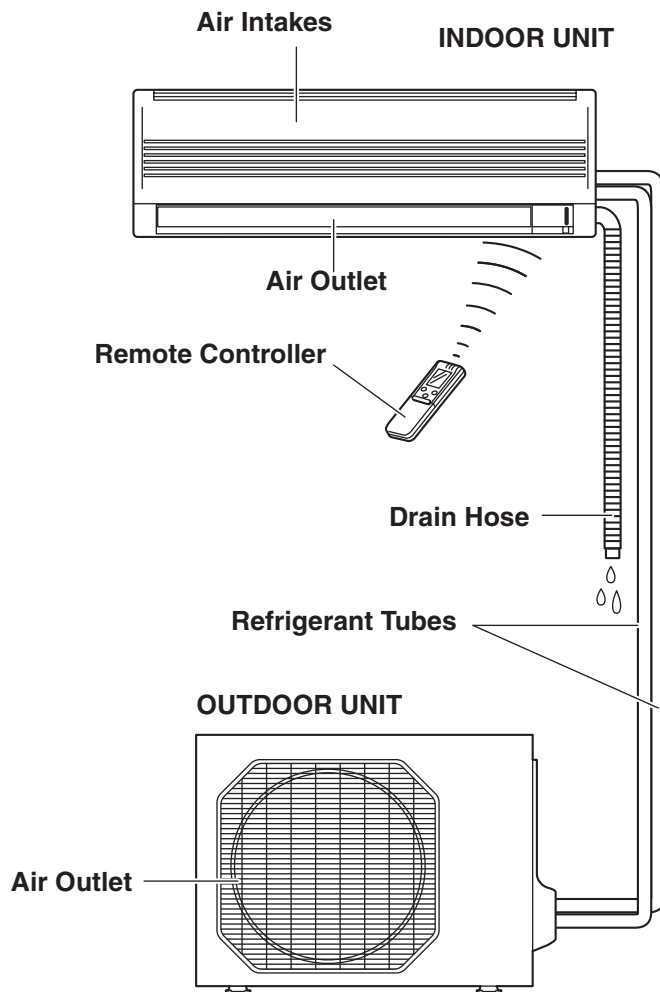
**CAUTION**

- Do not turn the air conditioner on and off from the power mains switch. Use the ON/OFF operation button.
- Do not stick anything into the air outlet of the outdoor unit. This is dangerous because the fan is rotating at high speed. 
- Do not touch the air inlet or the sharp aluminum fins of the outdoor unit. You may get injured. 
- Keep the fire alarm and the air outlet at least 1.5m away from the unit.
- Do not let children play with the air conditioner.
- Do not cool or heat the room too much if babies or invalids are present.
- Do not sit or step on the unit. You may fall down accidentally. 
- Do not stick any object into the FAN CASE. You may be injured and the unit may be damaged.   


**NOTICE**

- **This device complies with part 15 of the FCC Rules.** Operation is subject to the following two conditions:  
(1) This device may not cause harmful interference, and (2) this device must accept any interference received, including interference that may cause undesired operation.
- **This equipment has been tested and found to comply with the limits for a Class B digital device, pursuant to part 15 of the FCC Rules.** These limits are designed to provide reasonable protection against harmful interference in a residential installation. This equipment generates, uses and can radiate radio frequency energy and, if not installed and used in accordance with the instructions, may cause harmful interference to radio communications. However, there is no guarantee that interference will not occur in a particular installation. If this equipment does cause harmful interference to radio or television reception, which can be determined by turning the equipment off and on, the user is encouraged to try to correct the interference by one or more of the following measures:
  - Reorient or relocate the receiving antenna.
  - Increase the separation between the equipment and receiver.
  - Connect the equipment into an outlet on a circuit different from that to which the receiver is connected.
  - Consult the dealer or an experienced radio/TV technician for help.
- FCC Caution: To assure continued compliance, follow the attached installation instructions. Any changes or modifications not expressly approved by the party responsible for compliance could void the user's authority to operate this equipment.

## NAMES OF PARTS



EG

**NOTE**

This illustration is based on the external view of a standard model. Consequently, the shape may differ from that of the air conditioner which you have selected.

This air conditioner consists of an indoor unit and an outdoor unit. You can control the air conditioner with the remote controller.

<b>Air Intake</b>	Air from the room is drawn into this section and passes through air filters which remove dust.
<b>Air Outlet</b>	Conditioned air is blown out of the air conditioner through the air outlet.
<b>Remote Controller</b>	The remote controller controls power ON/OFF, operation mode selection, temperature, fan speed, timer setting, and air sweeping.
<b>Refrigerant Tubes</b>	The indoor and outdoor units are connected by copper tubes through which refrigerant gas flows.
<b>Drain Hose</b>	Moisture in the room condenses and drains off through this hose.
<b>Outdoor (Condensing) Unit</b>	The outdoor unit contains the compressor, fan motor, heat exchanger coil, and other electrical components.

## UNIT DISPLAY AND OPERATION BUTTON

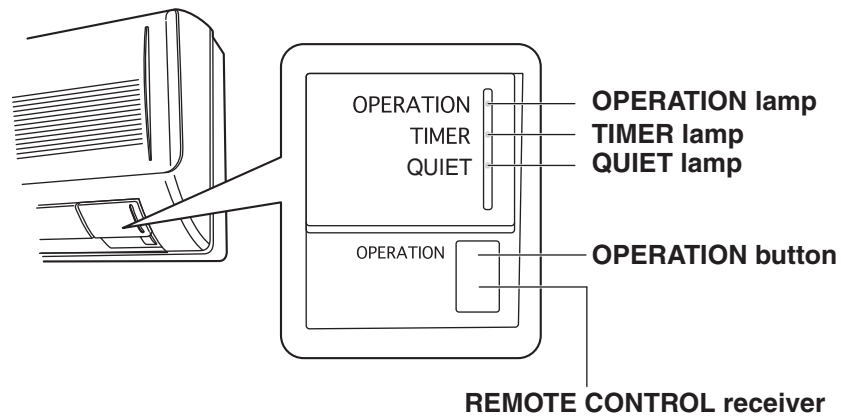


### IMPORTANT

Avoid using radio equipment such as mobile phone near (within 4 ft. (1.2 m)) the remote control receiver. Some radio equipment may cause malfunction of the unit.

If the trouble happens, disconnect power and restart the air conditioner after a few minutes.

### INDOOR UNIT

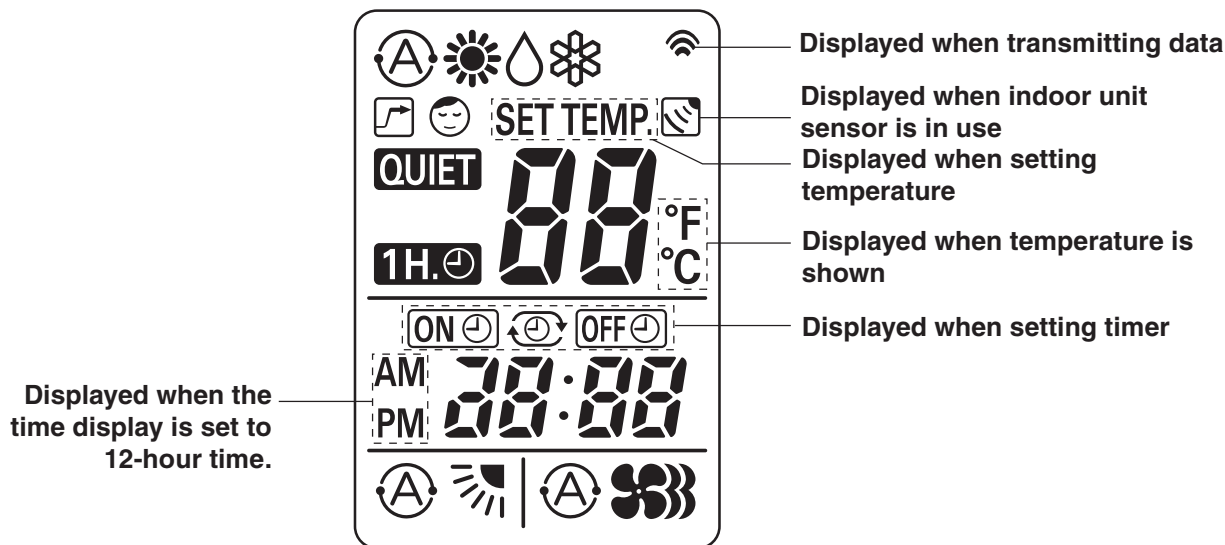


<b>REMOTE CONTROL receiver</b>	This section picks up infrared signals from the remote controller (transmitter).
<b>OPERATION button</b>	<p>When the remote controller cannot be used, pressing this button enables heating and cooling operation.</p> <p>Each time this button is pressed, the type of operation conducted is indicated by the changing color of the OPERATION lamp. Press the button and select the lamp color that suits your preference for operation.</p> <div style="text-align: center;"> <p>Cooling operation (green) → Heating operation (red) → Stop (lamp off)</p> </div>
<b>OPERATION lamp</b>	This lamp lights when the system is in the continuous AUTO (red or green), HEAT (red), DRY (orange) and COOL (green) mode. The OPERATION lamp lights up red and orange alternately when the system is defrosting.
<b>TIMER lamp</b>	This lamp lights when the system is being controlled by the timer.
<b>QUIET lamp</b>	This lamp lights during operation in the QUIET mode.

### NOTE

The unit's display lamps are dimmed during operation in the NIGHT SETBACK mode.

## REMOTE CONTROLLER (DISPLAY)

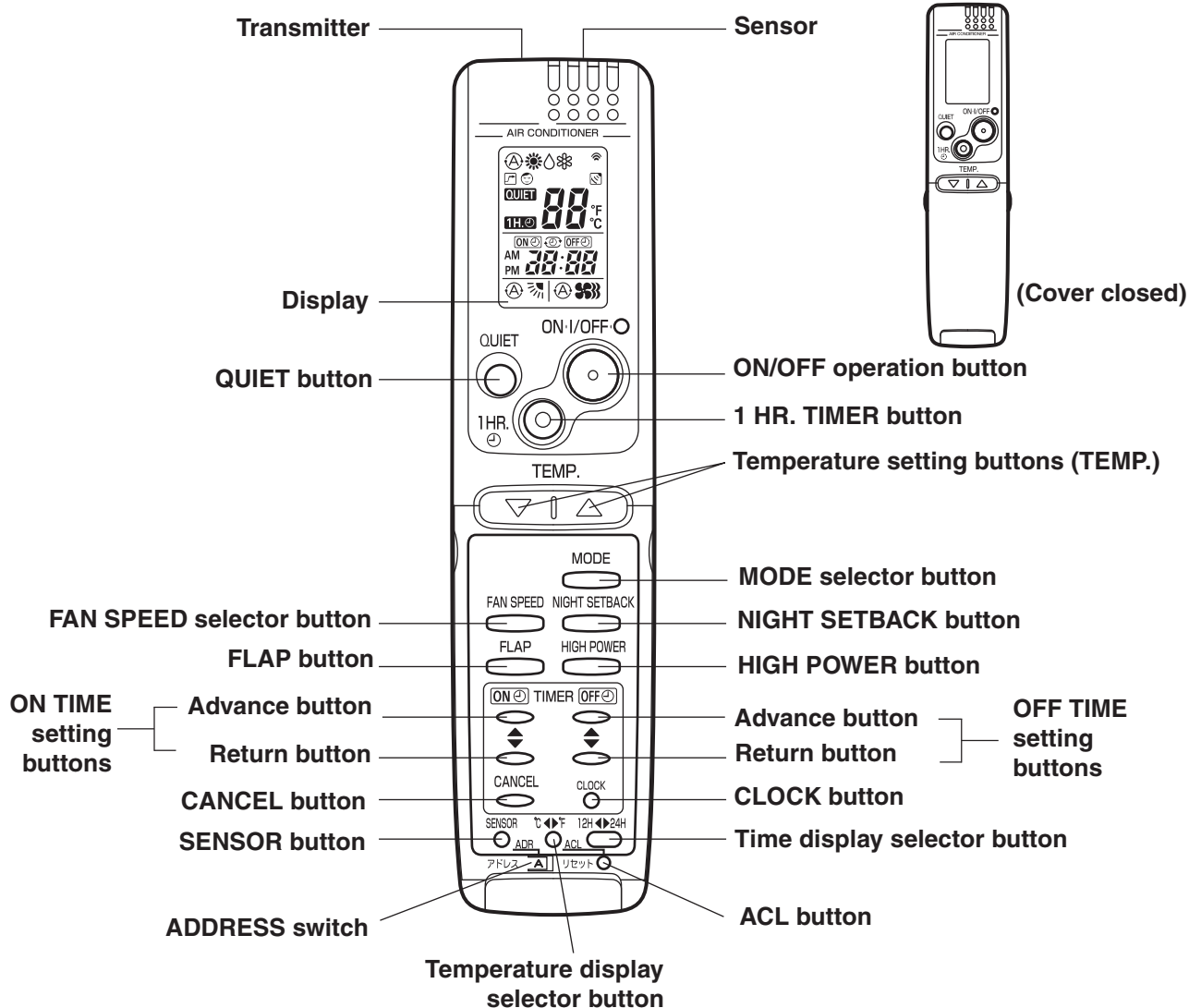


EG




### Symbols

(1) Operation mode		(4) Timer	
AUTO .....		24-hour clock with ON/OFF program Timer .....	
HEAT .....		ON Timer. ....	
MILD DRY .....		OFF Timer. ....	
COOL .....		1-hour OFF Timer. ....	
(2) Fan speed		(5) NIGHT SETBACK .....	
Automatic operation .....		(6) Confirmation of transmission .....	
HIGH .....		(7) Auto. flap indication .....	
MEDIUM .....		Flap angle indication .....	
LOW .....		Sweep indication .....	
(3) Temperature setting		(8) High power operation .....	
60 – 86 °F		(9) Quiet operation .....	
When set to 80 °F			
temperature indication .....			

# REMOTE CONTROLLER

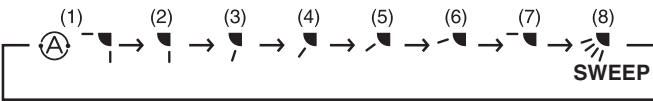


**NOTE** The illustration above pictures the remote controller after the cover has been opened.

<b>Transmitter</b>	When you press the buttons on the remote controller, the  mark appears in the display to transmit the setting changes to the receiver in the air conditioner.
<b>Sensor</b>	A temperature sensor inside the remote controller senses the room temperature.
<b>Display</b>	Information on the operating conditions is displayed while the remote controller is switched on. If the unit is turned off, FLAP setting and FAN SPEED setting are not displayed.
<b>QUIET button</b>	<b>QUIET</b> : When you press this button, the fan rotates slower than the fan speed setting to provide a quieter operating sound.
<b>ON/OFF operation button</b>	This button is for turning the air conditioner on and off.
<b>1 HR. TIMER button (1-HOUR OFF TIMER)</b>	<b>1H.</b> : When you press this button, regardless of whether the unit is operating or stopping, the unit operates for one hour and then shuts down.
<b>Temperature setting buttons (TEMP.)</b>	Press the  button to increase the set temperature. Press the  button to reduce the set temperature. The temperature setting changes by 1 °C or 2 °F each time one of the TEMP. buttons is pressed.

## REMOTE CONTROLLER (CONTINUED)

EG

<p><b>MODE selector button</b></p> <p>(AUTO)</p> <p>(HEAT)</p> <p>(DRY)</p> <p>(COOL)</p> <p><b>NOTE</b></p>	<p>Use this button to select AUTO, HEAT, DRY or COOL mode.</p> <p>Ⓐ : The air conditioner calculates the difference between the thermostat setting and room temperature, and automatically selects “COOL” or “HEAT” mode as appropriate.</p> <p>☀ : The air conditioner makes the room warmer.</p> <p>💧 : The air conditioner reduces the humidity in the room.</p> <p>❄ : The air conditioner makes the room cooler.</p> <p>When multiple indoor units are used and units in other rooms are already operating, they will be set to the same mode of operation as the operating indoor units.</p>
<p><b>FAN SPEED selector button</b></p>	<p>Ⓐ ⚙ : The air conditioner automatically decides the fan speeds.</p> <p>⚙ : High fan speed</p> <p>⚙ : Medium fan speed</p> <p>⚙ : Low fan speed</p>
<p><b>NIGHT SETBACK button</b></p>	<p>For details, see “4. Night Setback Mode”. When you press this button in the HEAT, DRY or COOL mode, the ☹ mark appears in the display, and the remote controller will automatically adjust the set temperature to save energy.</p>
<p><b>FLAP button</b></p> <p><b>NOTE</b></p>	<p>Press this button either to select the setting of the airflow direction to the auto. flap in each mode or one of the six possible positions manually or to select the sweep function which moves the flap up and down automatically.</p> <p>Ⓐ ↕ : Auto flap setting: If selected in a heating operation, the flap is set to position (3) in the following chart. If selected in a cooling or dry operation, the flap is set at position (7) in the following chart.</p> <p>↕ : The airflow direction can be set manually. (six positions)</p> <p>↕ : The flap moves up and down automatically.</p> <p>When you press the FLAP button, the air flow direction will be changed one by one as follows.</p> 
<p><b>HIGH POWER button</b></p>	<p>⚡ : If this button is pressed during HEAT, DRY or COOL operation, the unit operates at maximum output for 30 minutes, regardless of the desired temperature. The fan speed is 1 step above “High”.</p>
<p><b>ON TIME/OFF TIME setting buttons</b></p>	<p>No display: The timer does not operate.</p> <p>⌚ : The air conditioner starts at the set time.</p> <p>⌚ : The air conditioner stops at the set time.</p> <p>⌚ ⏪ ⌚ : The air conditioner stops and starts, or starts and stops, at the set times every day. For details, see “SETTING THE TIMER”.</p>
<p><b>SENSOR button</b></p> <p><b>NOTE</b></p>	<p>When you press this button (use a small-tipped object such as a ballpoint pen), the 📏 mark will appear at the display. And the room temperature is detected by the sensor which is built into the indoor unit and the air conditioner is controlled accordingly.</p> <p>If the remote controller is located near a heat source, such as a space heater or in direct sunlight, press the SENSOR button to switch to the sensor on the indoor unit.</p>

**NOTE** The indoor fan runs continuously when the system is in normal operation. It does not turn off when the desired room temperature is reached. If Night Set Back mode is selected, the fan will turn off intermittently during cooling operation in order to control air flow.

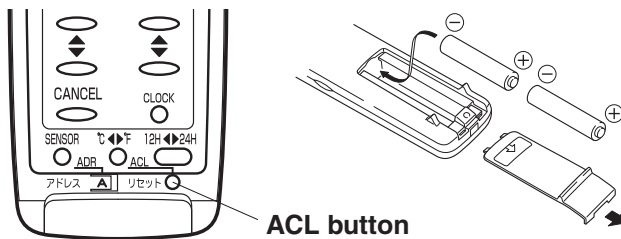
## REMOTE CONTROLLER (CONTINUED)

<b>Temperature Display Selector button</b>	This switches the temperature display between °C and °F.
<b>Time Display Selector button</b>	This switches the time display between 24-hour time and 12-hour time.
<b>ACL button (ALL CLEAR)</b>	Puts the remote controller into pre-operation status. Always press this button after replacing the batteries.
<b>ADDRESS switch</b>	<ul style="list-style-type: none"> <li>The address switch changes to prevent mixing of signals from remote controller's when two air conditioners are installed next to each other. Normally, the address switch is set to A. For more information, please contact the dealer where you made the purchase.</li> <li>Normally, the tabs on the remote controller should not be bent.</li> </ul>

**NOTE** The remote controller sends the temperature signal to the air conditioner regularly at five minute intervals. If the signal from the remote controller stops for more than 15 minutes due to the loss of the remote controller or other trouble, the air conditioner will switch to the temperature sensor which is built into the indoor unit and control the room temperature. In these cases, the temperature around the remote controller may differ from the temperature detected at the air conditioner's position.

## USING THE REMOTE CONTROLLER

### How to Install Batteries



- Slide the cover in the direction indicated by the arrow and remove it.
- Install two AAA alkaline batteries. Make sure the batteries point in the direction marked in the battery compartment.
- Use a thin object such as the tip of a pen to press the ACL button.



**CAUTION**

- The batteries last about six months, depending on how much you use the remote controller. Replace the batteries when the remote controller's display fails to light, or when the remote controller cannot be used to change the air conditioner's settings.
- Use two fresh leak-proof type-AAA alkaline batteries.
- In replacing batteries, follow the instructions as mentioned in the sub-section "How to Install Batteries".
- If you do not use the remote controller more than 1 month, take out the batteries.
- Dispose of the used batteries at the designated location in compliance with the applicable local ordinances.

### Information for Users on Collection and Disposal of Old Equipment and used Batteries



#### [Information on Disposal in other Countries outside the European Union]

These symbols are only valid in the European Union. If you wish to discard these items, please contact your local authorities or dealer and ask for the correct method of disposal.



#### Note for the battery symbol (bottom two symbol examples):

This symbol might be used in combination with a chemical symbol. In this case it complies with the requirement set by the Directive for the chemical involved.

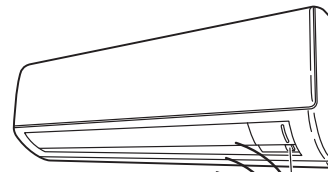


## USING THE REMOTE CONTROLLER (CONTINUED)

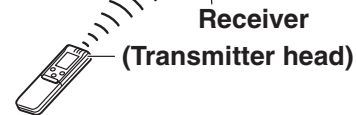
### How to Use the Remote Controller

When using the remote controller, always point the unit's transmitter head directly at the air conditioner's receiver.

**Air Conditioner  
(Indoor unit)**



**Remote Controller**



**Receiver**

**(Transmitter head)**

EG

### Remote Controller Installation Position

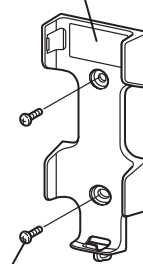
The remote controller may be operated either from a non-fixed position or from a wall-mounted position. To ensure that the air conditioner operates correctly, do not install the remote controller in the following places:

- In direct sunlight
- Behind a curtain or other places where it is covered
- More than 26 ft (8 m) away from the air conditioner
- In the path of the air conditioner's airstream
- Where it may become extremely hot or cold
- Where it may be subject to electrical or magnetic noise
- Where there is an obstacle between the remote controller and air conditioner (since a check signal is sent from the remote controller every 5 minutes)

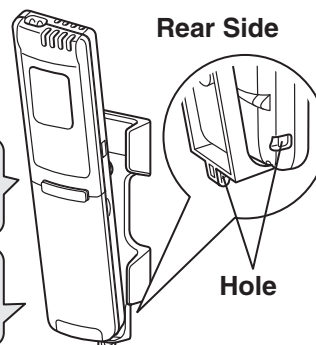
### Mounting the Remote Controller

Before mounting the remote controller, press the ON/OFF operation button at the mounting location to make sure that the air conditioner operates from that location. The indoor unit should make a beeping sound to indicate that it has received the signal.

**Remote Control Holder**



**Mounting Screws  
5/32 x 5/8" (4 x 16 mm)  
(included)**



- To prevent loss of the remote controller, you can connect the remote controller to the holder by passing a string through the remote controller and attachment hole.

**To take out the remote controller, pull it forward.**

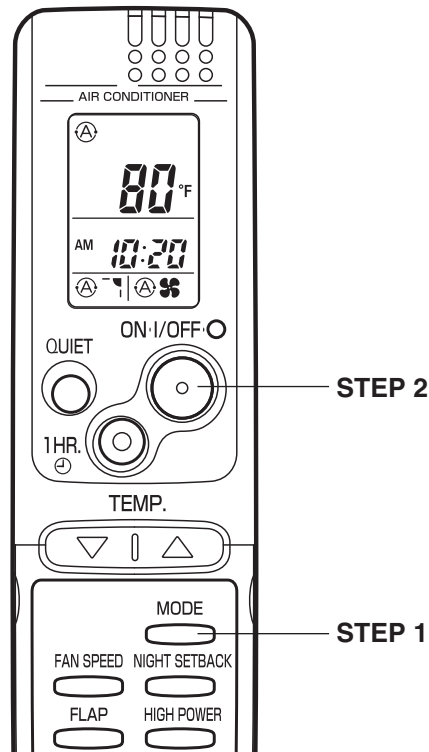
### When Holding the Remote Controller

- When using the remote controller and during air conditioner operation, the transmitter on the remote controller should be pointed towards the receiver on the indoor unit.
- Make sure that there are no objects between the remote controller and receiver which could block the signal.

# OPERATION WITH THE REMOTE CONTROLLER

## 1. Automatic Operation

The air conditioner calculates the difference between the thermostat setting and room temperature, and automatically determines the mode to operate under cooling or heating. Then, the air conditioner continuously operates under the mode selected at initial operation.



**NOTE** Check that the circuit breaker on the power panel is turned on.

Once mode is selected and the unit is preset by following the steps below, you can have the air conditioner automatically bring the room to the desired temperature simply by pressing the ON/OFF operation button.

<b>STEP 1</b>	Press the MODE selector button to .
<b>STEP 2</b>	Press the ON/OFF operation button.

To stop the air conditioner, press the ON/OFF operation button again.

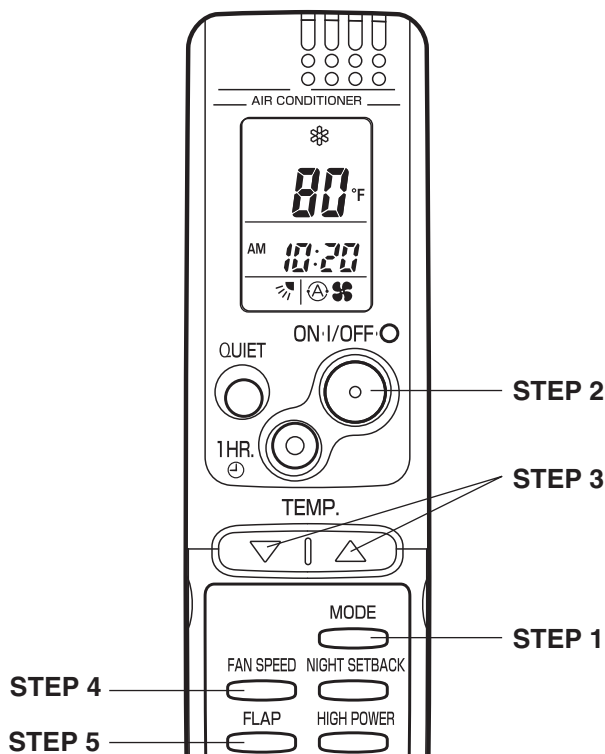
**NOTE**

- To change the temperature setting; press the temperature setting buttons and change the setting to the desired temperature.

## OPERATION WITH THE REMOTE CONTROLLER (CONTINUED)

### 2. Manual Operation

EG



**NOTE** Check that the circuit breaker on the power panel is turned on.

If the automatic operation settings of the unit do not meet your needs, press the setting buttons as described below and change the settings as desired.

<b>STEP 1</b>	Press the MODE selector button and select the desired mode. For heating operation → ☀ For dehumidifying operation → 💧 For cooling operation → ❄
<b>STEP 2</b>	To start the air conditioner, press the ON/OFF operation button.
<b>STEP 3</b>	Press the TEMP. setting buttons to change the temperature setting to the desired temperature. Adjustable temperature range: 30 °C max. or 86 °F max. 16 °C min. 60 °F min.
<b>STEP 4</b>	Set the FAN SPEED selector button to the setting you want.
<b>STEP 5</b>	Press the FLAP button and set the airflow direction as desired. (Refer to “ADJUSTING THE AIRFLOW DIRECTION” on page 21.)

To stop the air conditioner, press the ON/OFF operation button again.

**NOTE** When multiple indoor units are used and units in other rooms are already operating, they will be set to the same mode of operation as the operating indoor units.

---


## OPERATION WITH THE REMOTE CONTROLLER (CONTINUED)

**NOTE**




- Choose the best position in the room for the remote controller, which also acts as the sensor for room comfort and transmits the operating instructions. Once you've found this best position, always keep the remote controller there.
- This appliance has a built-in 5-minute time delay circuit to ensure reliable operation. When the operation button is pressed, the compressor will start running within three minutes. In the event of power failure, the unit will stop.

### 3. Adjusting the Fan Speed

**A. Automatic fan speed**

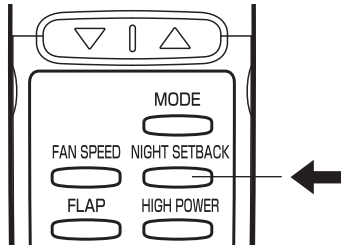
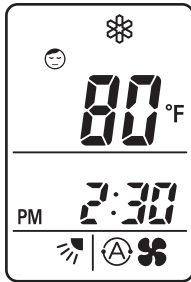
Simply set the FAN SPEED selector button to the  position. This automatically sets the best fan speed for the room temperature.

**B. Manual fan speed**

If you want to adjust fan speed manually during operation, just set the FAN SPEED selector button as desired. [, , or ]

## OPERATION WITH THE REMOTE CONTROLLER (CONTINUED)

### 4. Night Setback Mode



**Night Setback Mode is used for saving energy.**

Press the NIGHT SETBACK button while unit is operating.  
The ☺ mark appears in the display.

To release the night setback function, press the NIGHT SETBACK button again.

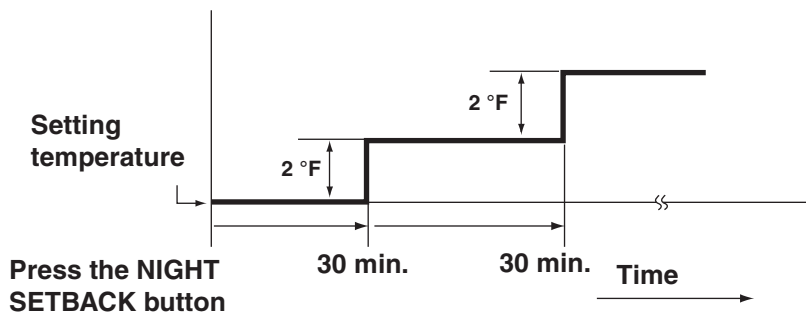
**NOTE**

Pressing the MODE selector button cancels Night Setback mode.

EG

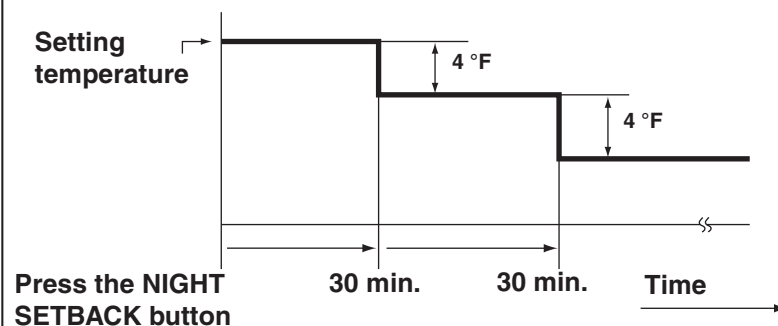
#### A. In Cooling and DRY Mode: (☼ and 💧)

When the night setback mode is selected, the air conditioner automatically raises the temperature setting 2 °F when 30 minutes have passed after the selection was made, and then another 2 °F after another 30 minutes have passed, regardless of the indoor temperature when night setback was selected. This enables you to save energy without sacrificing comfort. This function is convenient when gentle cooling is needed.



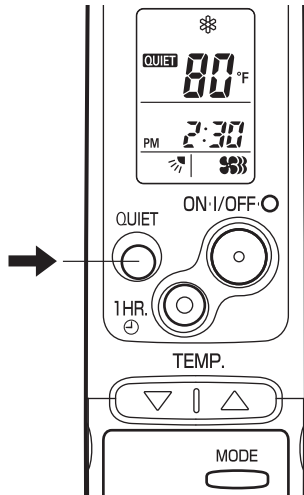
#### B. In Heating Mode: (☼)

When the night setback mode is selected, the air conditioner automatically lowers the temperature setting 4 °F when 30 minutes have passed after the selection was made, and then another 4 °F after another 30 minutes have passed, regardless of the indoor temperature when night setback was selected. This enables you to save energy without sacrificing comfort. This function is convenient when gentle heating is needed.



## OPERATION WITH THE REMOTE CONTROLLER (CONTINUED)

### 5. QUIET Mode



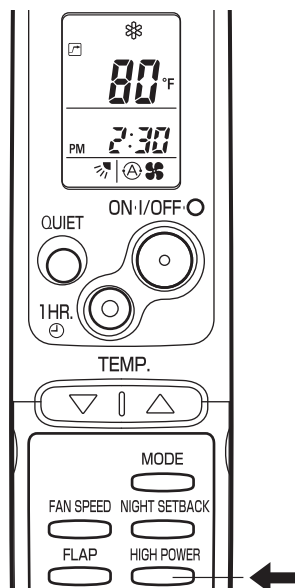
QUIET Mode is used to reduce the fan sound of the indoor unit.

Press the QUIET button.  
The **QUIET** mark appears in the display.


To cancel, press QUIET button again.

- In QUIET Mode, the fan rotates at a slower speed than the fan speed setting.
- If the unit is already operating with a very low airflow, the fan sound may not change even if the QUIET button is pressed.

### 6. HIGH POWER Mode




HIGH POWER mode can be used to increase the output of the indoor unit for all operation modes except automatic operation.

Press the HIGH POWER button while unit is operating.  
The  mark appears in the display.

To cancel, press HIGH POWER button again.

- When the HIGH POWER button is pressed, the unit operates at maximum output for 30 minutes, regardless of the desired temperature. The fan speed is 1 step above "High".
- HIGH POWER Mode cannot be used when the operation mode is in Automatic Operation.
- QUIET Mode and HIGH POWER Mode cannot be used at the same time.

#### NOTE

- Pressing the MODE selector button cancels HIGH POWER mode.
- When set to High fan speed during heating operation, the fan runs at High fan speed even though the  mark is displayed.
- Depending on the operating conditions, the fan speed may be increased by a small amount only.

---

## SPECIAL REMARKS

### “DRY” (☺) Operation

- How it works?**
- Once the room temperature reaches the level that was set, the unit's operation frequency is changed automatically.
  - During DRY operation, the fan speed automatically runs at lower speed for providing a comfortable breeze.
  - “DRY” operation is not possible if the indoor temperature is 59 °F or less.

EG

### Heating (☀) Operation

- Heating performance**
- Because this air conditioner heats a room by drawing in the heat of the outside air (heat pump system), the heating efficiency will fall off when the outdoor temperature is very low. If sufficient heat cannot be obtained with this air conditioner, use another heating appliance together with it.

- Defrosting**
- When the outdoor temperature is low, frost or ice may form on the heat exchanger coil, reducing heating performance. When this happens, a microcomputer defrosting system operates. At the same time, the fan on the indoor unit stops and the OPERATION lamp lights red and orange alternately until defrosting is completed. Heating operation restarts after several minutes. (This interval will vary slightly depending upon the outdoor temperature and the way in which frost forms.)

- Cold draft prevention**
- For several minutes after the start of heating operation, the indoor fan runs at a lower speed until the indoor heat exchanger coil has warmed up sufficiently. However, the fan may remain stopped when the room temperature is low. This is because the COLD DRAFT PREVENTION SYSTEM is in operating.

### Power failure during operation

- In the event of power failure, the unit will stop. When the power is resumed, the unit will restart automatically within 15 minutes by the remote controller.

### Clicking Sound

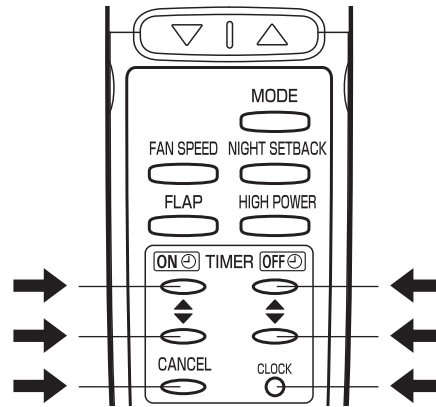
#### Clicking sound is heard from the air conditioner

- In heating or cooling operation, any plastic parts may expand or shrink due to a sudden temperature change. In this event, a clicking sound may occur. This is normal, and the sound will soon disappear.

### Remote Controller

- The remote controller sends the setting condition to the air conditioner regularly at five minute intervals.

## SETTING THE TIMER



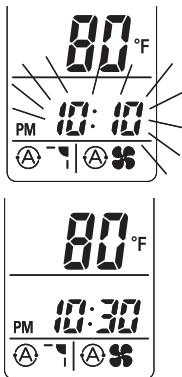
### NOTE

In the descriptions below, the following settings are used for the temperature and time indicator selector button on the bottom front section of the remote controller.

- Temperature: °F
- Time: AM, PM

### 1. How to set the present time

(Example) To set to 10:30 pm.



Operation	Indication
1. Press the CLOCK button once if the time indicator is not flashing.	The time indication alone flashes.
2. Press the Advance, Return (▲, ▼) button until PM 10:30 is displayed.	The time can be set in 1-minute increments. Holding down the button advances the time rapidly in 10-minute increments.
3. Press the CLOCK button again.	This completes the setting of the current time.

### 2. How to set the OFF time

(Example) To stop the air conditioner at 11:00 am.

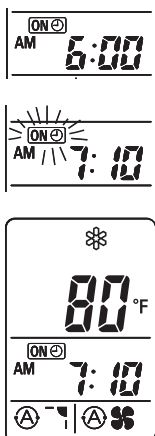


Operation	Indication
1. Press the OFF TIME setting button once.	The timer <b>OFF</b> indication is displayed, and the present OFF time is shown.
2. Press the Advance, Return (▲, ▼) button until AM 11:00 is displayed.	The timer <b>OFF</b> indication blinks. The time can be set in 10-minute increments. Holding down the button advances the time rapidly in 10-minute increments.
3. Wait a few seconds, and then the setting is complete.	The timer <b>OFF</b> indication stops blinking and the present time is displayed.

## SETTING THE TIMER (CONTINUED)

### 3. How to set the ON time

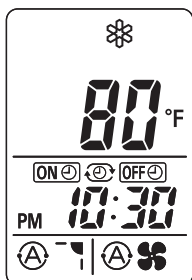
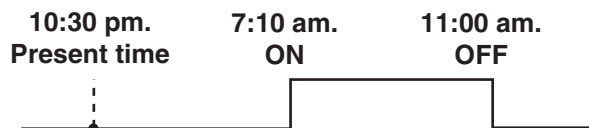
(Example) To start operation at 7:10 am.



Operation	Indication
1. Press the ON TIME setting button once.	The timer  indication is displayed, and the present ON time is shown.
2. Press the Advance, Return (, ) button until AM 7:10 is displayed.	The timer  indication blinks. The time can be set in 10-minute increments. Holding down the button advances the time rapidly in 10-minute increments.
3. Wait a few seconds, and then the setting is complete.	The timer  indication stops blinking and the present time is displayed.

### 4. How to set DAILY ON/OFF REPEAT timer

(Example) To start operation at 7:10 am. and stop the air conditioner at 11:00 am.



Operation	Indication
1. Set the timer ON/OFF times as shown in 2-1, 2, 3 and 3-1, 2, 3.	The present time 10:30 pm. and   are displayed.

#### NOTE

- The ON/OFF combination timer uses the current time as the reference, and it is activated starting from whichever set time comes first.
- With the ON/OFF combination timer, the settings are repeated every day.
- You can check the timer ON/OFF times after you have set them by pressing the ON TIME and OFF TIME setting buttons.

#### To cancel a timer program

- Press the CANCEL button.
- When either an ON or OFF timer is to be canceled, press the button corresponding to the timer whose program is to be canceled, and then press the CANCEL button.

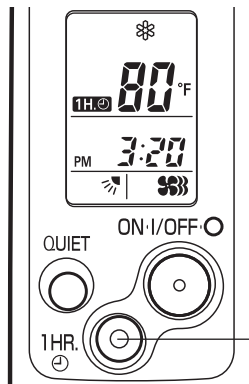
#### NOTE

- The airflow direction, fan speed and temperature setting can be changed after a timer program has been set even when the unit is stopped. Even when operation is stopped during an ON timer program, the unit will start operating when the set time is reached provided that the program is not canceled.
- When the ON timer and OFF timer are set to the same time, the timer operates as if it is turned off.

---

## USING THE 1-HOUR OFF TIMER

### 1. 1-Hour OFF Timer



#### NOTE

This function causes the unit to operate for one hour and then stop, regardless of whether the unit is on or off when this button is pressed. The **1H.** icon in the display indicates that this function is operating.

#### Setting procedure:

Regardless of whether the unit is operating or stopped, press the 1 HR. TIMER button.

**1H.** icon appears in the display.

#### Cancellation procedure:

Press the ON/OFF operation button to turn the unit off, wait for the unit to stop operating, and then press the ON/OFF operation button again.

The 1-Hour Timer function is now cancelled and the unit operates normally.

- If, while the 1-Hour Timer function is operating, the 1HR. TIMER button is pressed once to cancel the function and then again, the unit continues to operate for one hour from that point in time and then stops.
- It is not possible to use the OFF Timer and 1-Hour OFF Timer together. Whichever function is set last takes precedence. If the 1 HR. TIMER button is pressed while the TIMER OFF function operates, the OFF Timer is cancelled and the unit will stop operating one hour later.

### 2. Operation together with the DAILY ON/OFF REPEAT Timer

The 1-Hour OFF Timer setting is given priority over the DAILY ON/OFF REPEAT setting.

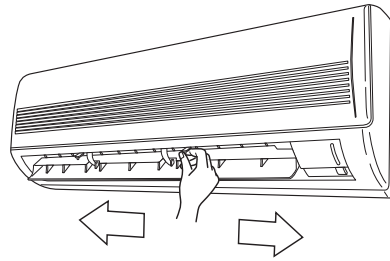
---

## TIPS FOR ENERGY SAVING

- Avoid**
- **Do not block neither the air intake nor the air outlet. It may cause less performance, and may leads to malfunctions.**
  - Do not let direct sunlight into the room. Use sunshades, blinds or curtains. If the walls and ceiling of the room are warmed by the sun, it will take longer to cool the room.
- Do**
- Always try to keep the air filter clean. (Refer to “CARE AND CLEANING”.) A clogged filter will impair the performance of the unit.
  - To prevent conditioned air from escaping, keep windows, doors and any other openings closed.

## ADJUSTING THE AIRFLOW DIRECTION

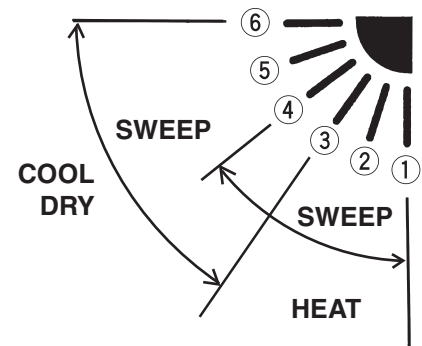
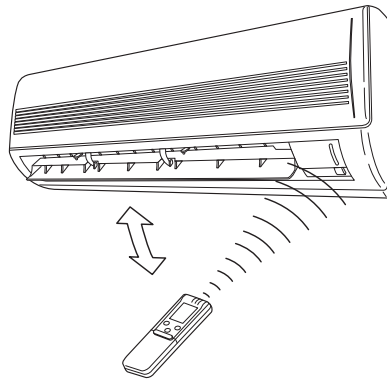
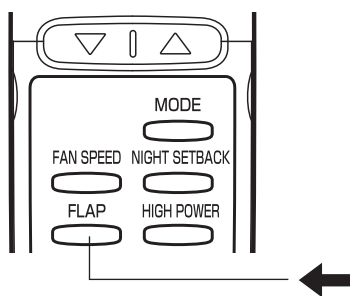
- 1. Horizontal** The horizontal airflow can be adjusted by moving the vertical vanes with your hands to the left or right.



### CAUTION

When the humidity is high, the vertical vanes should be in the front position during the cooling or dehumidifying operation. If the vertical vanes are positioned all of the way to the right or left, condensation may begin to form around the air vent and drip down.

- 2. Vertical** The vertical airflow can be adjusted by moving the flap with the remote controller. Do not move the flap with your hands. Confirm that the remote controller has been turned on. Use the FLAP button to set either the sweep function or one of the six airflow direction settings.



### A. Sweep function



The flap starts moving up and down to deliver air over the sweep range.

### C. Auto flap function



The flap is set to the recommended position.

### B. Setting the airflow manually



Referring to the above illustration, use the FLAP button to set the airflow direction within the range used during the heating, cooling, or dehumidifying operation.

### NOTE

- The flap automatically closes when the unit is off.
- During the heating operation, the fan speed will be very low and the flap will be in the horizontal position (position ⑥) until the air being blown out of the unit begins to warm. Once the air warms up, the flap position and fan speed change to the settings specified with the remote controller.

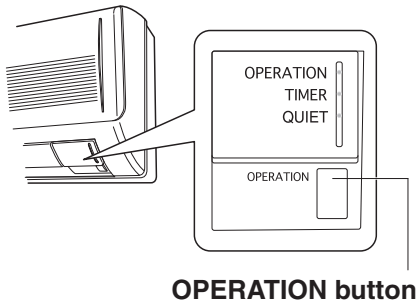


### CAUTION

- Use the FLAP button on the remote controller to adjust the position of the flap. If you move the flap by hand, the flap position according to the remote controller and the actual flap position may no longer match. If this should happen, shut off the unit, wait for the flap to close, and then turn on the unit again; the flap position will now be normal again.
- Do not have the flap pointed down during cooling operation. Condensation may begin to form around the air vent and drip down.

## OPERATION WITHOUT THE REMOTE CONTROLLER

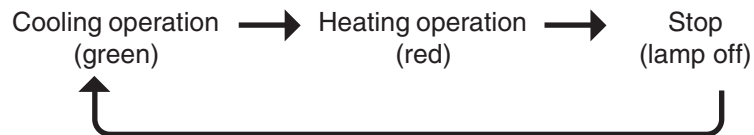
### INDOOR UNIT



If you have lost the remote controller or it has trouble, follow the steps below.

#### When the air conditioner is not running

Each time the OPERATION button is pressed, the type of operation conducted is indicated by the changing color of the OPERATION lamp. Press the button and select the lamp color that suits your preference for operation.



#### NOTE

The temperature is set to the room temperature minus 4 °F during the cooling operation and to the room temperature plus 4 °F during the heating operation, and the fan speed and flap are set to Auto.

## CARE AND CLEANING



#### WARNING

1. For safety, be sure to turn the air conditioner off and also to disconnect the power before cleaning.
2. Do not pour water on the indoor unit to clean it. This will damage the internal components and cause an electric shock hazard.

#### Casing and Grille (Indoor Unit)

Clean the casing and grille of the indoor unit with a vacuum cleaner brush, or wipe them with a clean, soft cloth.

If these parts are stained, use a clean cloth moistened with a mild liquid detergent. When cleaning the grille, be careful not to force the vanes out of place.



#### CAUTION

1. Never use solvents, or harsh chemicals when cleaning the indoor unit. Do not wipe the plastic casing using very hot water.
2. Some metal edges and the fins are sharp and may cause injury if handled improperly; be especially careful when you clean these parts.
3. The internal coil and other components of the outdoor unit must be cleaned every year. Consult your dealer or service center.

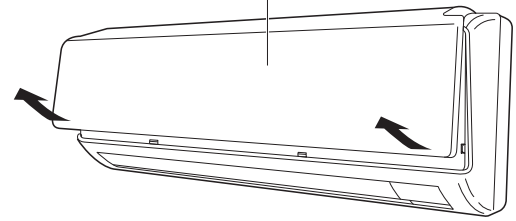
## CARE AND CLEANING (CONTINUED)

**Filter** The filter behind the air intake grille should be checked and cleaned at least once every two weeks.

### How to remove the filter

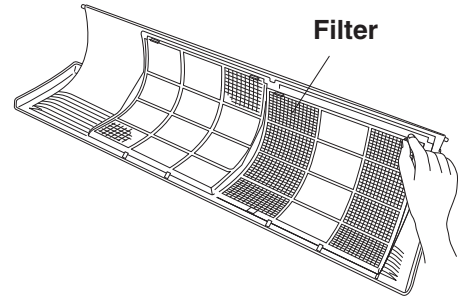
1. Grasp both ends of the air intake grille, and remove it by opening towards the front and pulling towards you.

Air intake grille



2. Remove the filter attached to the rear of the air intake grille.

Filter



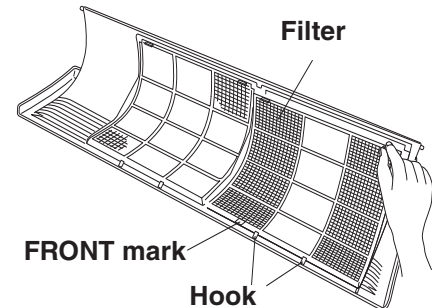
### Cleaning

Use a vacuum cleaner to remove light dust. If there is sticky dust on the filter, wash the filter in lukewarm, soapy water, rinse it in clean water, and dry it.

### How to replace the filter

1. With the FRONT mark of the filter at the front, align the two indentions near the mark with the hooks at the rear of the air intake grille, and then mount the filter.

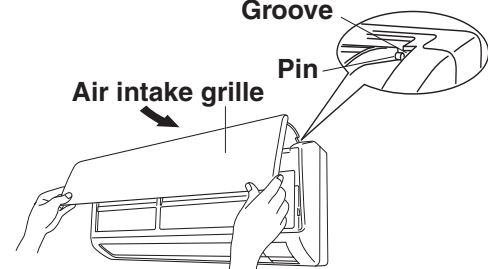
Filter



2. Allow the edge of the air intake grille to slide into the top of the indoor unit, and then insert it all the way inside.

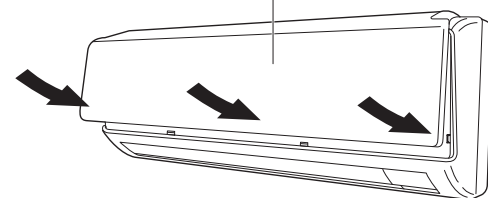
Groove

Air intake grille



3. To attach the air intake grille to the indoor unit, press its bottom right and left corners as well as its bottom center into place.

Air intake grille



### NOTE

Attach so that the round pins at the top right and left corners of the air intake grille are inserted into the grooves at the top right and left of the indoor unit.

---

## CARE AND CLEANING (CONTINUED)

### Cleaning the main unit and remote controller

- Wipe clean using a soft, dry cloth.
- To remove stubborn dirt, moisten a cloth in warm water no hotter than 104 °F, wring thoroughly, and then wipe.
- The air intake grille can be removed in order to wash it with water.

### Removing and remounting the air intake grille

Refer to “How to remove the filter” and “How to replace the filter” on page 23.



**CAUTION**

**When using a footstool or the like, be careful not to let it tip over.**

### Washing the grille with water

- Clean the grille gently using a soft sponge, or the like. Then wipe away any remaining moisture.
- Neutral detergent may be used to remove stubborn dirt. Then rinse thoroughly with water and wipe away any remaining moisture.

---

## WIRED REMOTE CONTROLLER

A separately sold wired remote controller (CZ-RD515U) used with this air conditioner is also available. If you wish to use the wired remote control function, you will need to purchase both the optional wired remote controller and its connection kit (CZ-RC515U).

## TROUBLESHOOTING (BEFORE CALLING FOR SERVICE)

If your air conditioner does not work properly, first check the following points before requesting service. If it still does not work properly, contact your dealer or service center.

Trouble	Possible Cause	Remedy
Air conditioner does not run at all.	<ol style="list-style-type: none"> <li>1. Power failure.</li> <li>2. Leakage circuit breaker tripped.</li> <li>3. Line voltage is too low.</li> <li>4. Batteries in remote controller have run down.</li> </ol>	<ol style="list-style-type: none"> <li>1. Restore power.</li> <li>2. Contact service center.</li> <li>3. Consult your electrician or dealer.</li> <li>4. Replace batteries.</li> </ol>
OPERATION lamp blinks and air conditioner does not operate.	Trouble in system.	Contact service center.
Compressor runs but soon stops.	Obstruction in front of condenser coil. (Outdoor Unit)	Remove obstruction.
Poor cooling (or heating) performance.	<ol style="list-style-type: none"> <li>1. Dirty or clogged air filter.</li> <li>2. Heat source or many people in room.</li> <li>3. Doors and/or windows are open.</li> <li>4. Obstacle near air intake or air discharge port.</li> <li>5. Thermostat is set too high for cooling (or too low for heating).</li> <li>6. (Outdoor temperature is too low for heating.)</li> </ol>	<ol style="list-style-type: none"> <li>1. Clean air filter to improve airflow.</li> <li>2. Eliminate heat source if possible.</li> <li>3. Shut them to keep the heat (or cold) out.</li> <li>4. Remove it to ensure good airflow.</li> <li>5. Set the temperature lower (or higher).</li> <li>6. (Consult your dealer or try to use another heat appliance.)</li> </ol>
Clicking sound is heard from the air conditioner.	In heating or cooling operation, any plastic parts may expand or shrink due to a sudden temperature change. In this event, a clicking sound may occur.	This is normal, and the sound will soon disappear.
OPERATION lamp lights but outdoor unit will not run.	The use of cellular phones near the air conditioner may cause disturbance to its normal operation.	<ol style="list-style-type: none"> <li>1. Turn off the power then restart the air conditioner after a while.</li> <li>2. Consult your dealer.</li> </ol>

## OPERATING RANGE

The air conditioner is operable within the temperature ranges as listed below:

	Temperature	Indoor air temperature	Outdoor air temperature
COOLING	Max.	95 °F DB / 71 °F WB	115 °F DB
	Min.	67 °F DB / 57 °F WB	14 °F DB
HEATING	Max.	80 °F DB / 67 °F WB	75 °F DB / 65 °F WB
	Min.	– DB / – WB	– DB / 0 °F WB

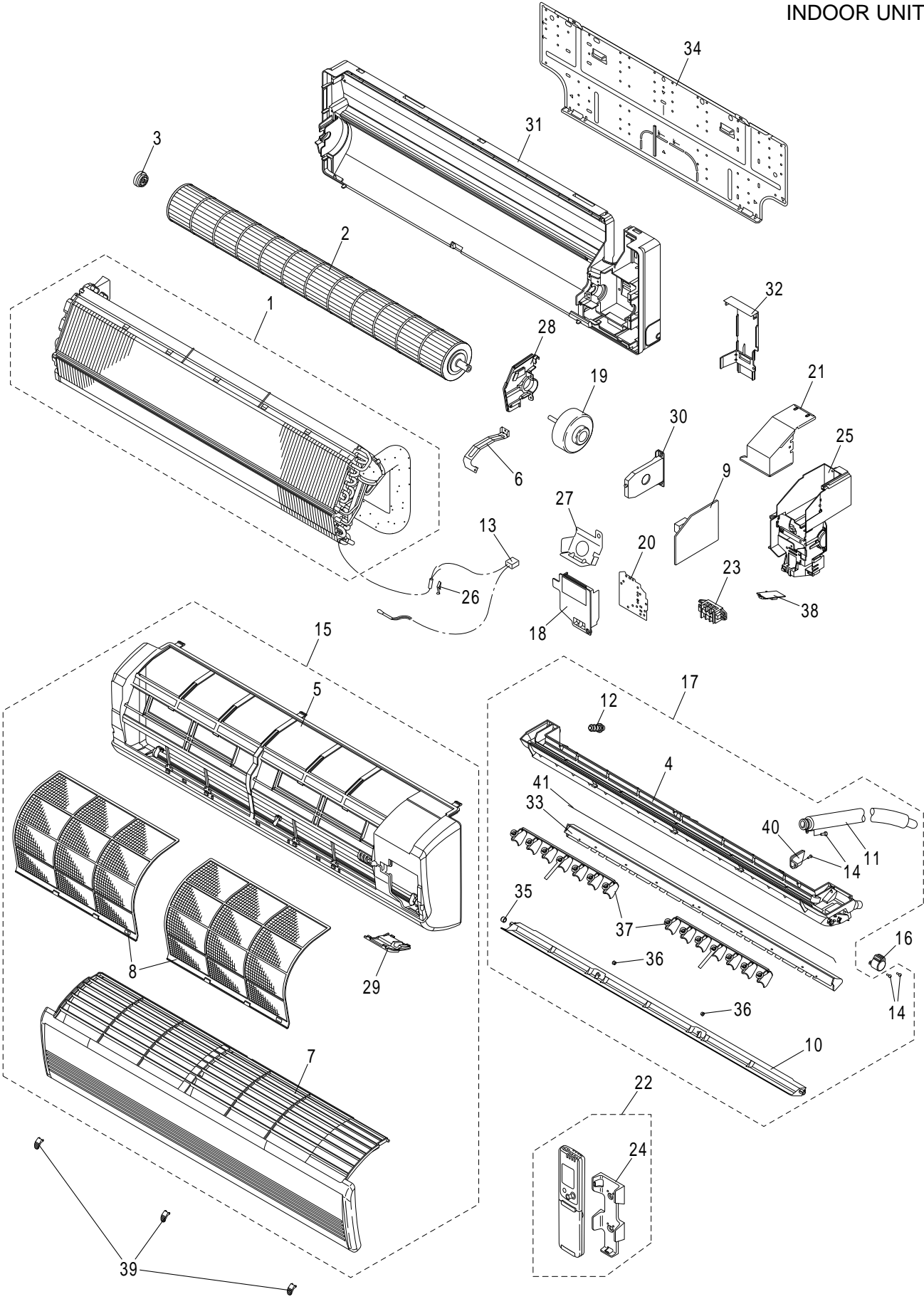
# SPECIFICATIONS

Model No.		Indoor Unit		
		CS-MKE18NKU	CS-MKE24NKU	
Power Source		Single-phase, 208-230 V, 60 Hz		
Cooling Capacity	kW	5.15	7.10	
	BTU/h	17,500	24,200	
Heating Capacity	kW	6.00	8.50	
	BTU/h	20,400	29,000	
Operation Sound	Cooling Operation (H/M/L) dB(A)	41/38/34	44/41/38	
	Heating Operation (H/M/L) dB(A)	40/37/34	43/40/37	
Unit Dimensions (HxWxD) (Indoor unit : Include panel)		inch (mm)	11-23/32x41-15/16x8-5/8 (298x1,065x219)	11-23/32x41-15/16x8-5/8 (298x1,065x219)
Net Weight		lbs. (kg)	26.5 (12.0)	26.5 (12.0)

Model No.		Outdoor Unit			
		CU-3KE19NBU	CU-4KE24NBU	CU-4KE31NBU	
Power Source		Single-phase, 208-230 V, 60 Hz			
Cooling Capacity	kW	5.45 [2.90 ~ 5.45]	6.80 [2.90 ~ 6.80]	9.00 [2.90 ~ 9.00]	
	BTU/h	18,600 [9,800 ~ 18,600]	23,200 [9,800 ~ 23,200]	30,600 [9,800 ~ 30,600]	
Heating Capacity	kW	7.30 [3.40 ~ 7.30]	8.60 [3.40 ~ 8.60]	9.40 [3.40 ~ 9.40]	
	BTU/h	24,800 [11,600 ~ 24,800]	29,200 [11,600 ~ 29,200]	32,000 [11,600 ~ 32,000]	
Operation Sound	Cooling Operation (Hi) dB(A)	50	50	53	
	Heating Operation (Hi) dB(A)	52	52	52	
Unit Dimensions (HxWxD)		inch (mm)	29-1/8x35-7/16x12-19/32 (740x900x320)	29-1/8x35-7/16x12-19/32 (740x900x320)	35-1/32x35-7/16x12-19/32 (890x900x320)
Net Weight		lbs. (kg)	143.3 (65.0)	143.3 (65.0)	180.8 (82.0)



CS-MKE18NKU  
INDOOR UNIT



## ATTENTION!

To ensure correct parts supply, please let us know the following,

Part No. when you make service parts order:

1.Part No. 2.Description 3.Q'ty 4.Volts-Hz-Ph 5.Product Mode No.

CS-MKE18NKU  
INDOOR UNIT

KeyNo.	Part No.	Description	Model Number	Q'ty	Reference No.	
1	CV6231917537	Evaporator Ass'y		1	8520411693000	
*	2	CV6231845397	Cross-Flow Fan Ass'y	1	8520250929200	
*	3	CV6231718318	Bearing Housing Ass'y	1	8520251013200	
4	CV6231917520	Air Outlet Frame		1	8522153121011	
5	CV6231917513	Grille		1	8522150152211	
6	CV6231845366	Mounting Plate		1	8522238512801	
7	CV6233189345	Ornamental Plate		1	8522151638712	
8	CV6233189338	Air Filter Ass'y		2	8520230739201	
*	9	CV6233189628	Circuit Board Ass'y	CB-CS-MKE18NKU	1	8FA0518190000
10	CV6231917551	Flap		1	8522152330011	
11	CV6231772235	Drain Hose Ass'y		1	8520130329400	
12	CV6231718363	Cap, Drain Pan		1	8522234812401	
*	13	CV6233189369	Thermistor Ass'y	PTM-D51H-S4-2	1	8FA0525962800
14	CV6231510646	Screw Special	SWCH18A	4	8522239615101	
15	CV6233189352	Grille Ass'y		1	8520150194000	
*	16	CV6231772204	Step Motor	MP24Z3-12V	1	1FA4M3A000900
17	CV6233189390	Air Outlet Ass'y		1	8520153141700	
18	CV6231932363	Terminal Cover Ass'y		1	8520530907900	
*	19	CV6233189383	Fan Motor	SIC-41CVJ-D847-3	1	1FA4M5B011600
20	CV6231845489	Mounting Plate		1	8522238513001	
21	CV6231845472	Cover Plate		1	8522530941401	
*	22	CV6233187020	Remote Control Switch	PRCS-3HVPSS4EE-T	1	8FA0005458800
23	CV6230032996	Terminal Base	KTU15N-3J	1	4237956159	
24	CV6233003573	Holder		1	8512537707701	
25	CV6231917667	Elec. Component Box		1	8522530770911	
26	CV6231485876	Mounting Thermostat		1	8522530322401	
27	CV6231917650	Angle Terminal		1	8522530636301	
28	CV6231917643	Mounting Plate Ass'y		1	8520221718200	
29	CV6233189406	Sash ORN Ass'y		1	8520130136700	
30	CV6231917629	Mounting Plate, Fan Motor		1	8522235430711	
31	CV6231917612	Frame Ass'y		1	8520220143600	
32	CV6231917605	Mounting, Tube		1	8522236230212	
33	CV6231917698	Guide Air Defl		1	8522236019711	
34	CV6231845625	Rear Panel		1	8522223022901	
35	CV6231469104	Mounting		1	8522151452001	
36	CV6380037209	Mounting		2	8522151444002	
37	CV6231917681	Blade		2	8522151935411	
*	38	CV6231907750	P.C.B. Ass'y	IND-KRV184EH	1	8FA0517862700
39	CV6231917674	Cap		3	8522235024211	
40	CV6233189413	Mounting		1	8522151470911	

NOTE: Metal and plastic parts will be supplied basically with necessary heat insulation pads or packing. Each key number with an asterisk (\*) means the recommended service parts.

**ATTENTION!**

To ensure correct parts supply, please let us know the following,

Part No. when you make service parts order:

CS-MKE18NKU  
INDOOR UNIT

1.Part No. 2.Description 3.Q'ty 4.Volts-Hz-Ph 5.Product Mode No.

KeyNo.	Part No.	Description	Model Number	Q'ty	Reference No.
41	CV6231920513	Wire		1	8522131536101
	CV6233187600	Operation Manual		1	8526418121800

NOTE: Metal and plastic parts will be supplied basically with necessary heat insulation pads or packing. Each key number with an asterisk (\*) means the recommended service parts.

## Split System Submittal Data

Indoor: **CS-MKE18NKU**

Multi System Indoor Units - Wall Mounted

Job Name: \_\_\_\_\_  
 Location: \_\_\_\_\_  
 Engineer: \_\_\_\_\_  
 Submitted to: \_\_\_\_\_  
 Submitted by: \_\_\_\_\_  
 Reference: \_\_\_\_\_

Approval: \_\_\_\_\_  
 Date: \_\_\_\_\_  
 Construction: \_\_\_\_\_  
 Unit#: \_\_\_\_\_  
 Drawing#: \_\_\_\_\_



General Data	
<b>Power (V/P/Hz)</b>	<b>208 - 230/1/60</b>
Circuit Ampacity (A)	15
Fuse Size, Max.(A)	20
Running Amps (A)	0.15
Power Input (W)	35
Indoor Unit	Cool/Heat
Fan type	Cross Flow
Dia & Length (in.) - No. Speeds	D3-11/16 L33-9/32 -1
No. Speeds	3 & Auto
No. Poles (RPM, High)	8 - 1200/1200
No. Motors (W)	1-(30)
CFM (HI)	500/500
Operation Sound (HI/Med/Lo/QT*dB-A)	41/38/34/28 40/37/34/38
Coil Type	Aluminum Plate Fin & Copper Tube
Fin Type - Pipe Type	Slit Plate - Inner Rifled
Rows - F.P.I.	2 - 19.5
Face Area (sq.ft.)	3.07
Tube Size (in)	9/32
Drain Connection Size	23/32
Refrigerant	R410A
Line Size (in. O.D. Discharge)	1/4" (Flare)
Line Size (in. O.D. Discharge)	1/2" (Flare)
Dimensions (HxWxD)	
Indoor Unit (Crated) (in.)	11-3/8 x 44-7/8 x 14-29/32
Indoor Unit (Uncrated) (in.)	11-23/32 x 41-15/16 x 8-19/32
Weight (lbs.)	Indoor
Net	26.5
Shipping	33.1
Shipping Volume (cu.ft.)	4.23

Performance Data @ ARI Standard Conditions (230V)	
Cooling	
Total Capacity (BTU/H)	17500
Moisture Removal (HI, Pint/H)	4.89

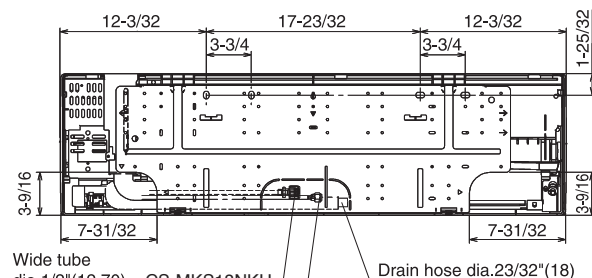
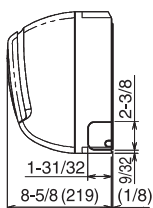
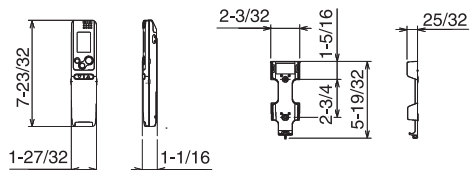
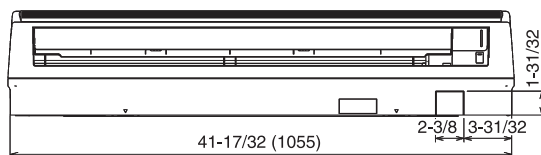
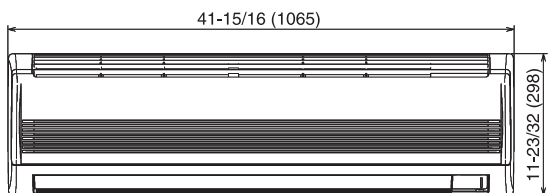
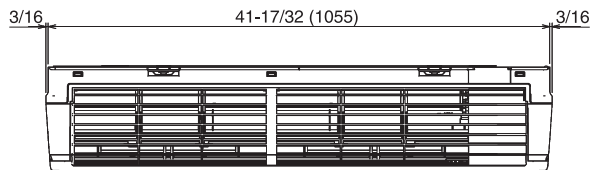
Cooling	
Total Capacity (BTU/H)	20400

Features	
Controls	Microprocessor
Remote Control	LCD Wireless Type, Built-in Temp Sensor
Temperature Control	IC Thermostat
Timer	24 Hr. Program, 1 Hr. Off
Night Setback	Built-In
Air Louver, Horizontal	Manual
Air Louver, Vertical	Automatic
Power Failure Automatic Restart	Built-In
Heating/Cooling Automatic Changeover	Built-In
Self-Diagnosis	Built-In
Quiet Operation	Built-In
Air Filter	Washable, Anti-Mold
Ion Generator	N/A
Air Clean Apatite Filer	N/A

Option	
Refrigerant Line Set	Available
Fresh Air Intake	N/A
Air duct Extension	N/A
Indoor Frame Extension	N/A
Condensate Drain Pump	Available
Non-Removeable Remo-con Bracket	Available

Operating Range	Indoor Air Intake Temp	Outdoor Air Intake Temp
Cooling (Max)	95F DB/71F WB	115F DB
Cooling (Min)	67F DB/57F WB	14F DB
Heating (Max)	80F DB/67F WB	75F DB/65F WB
Heating (Min)	-DB/-WB	0 DB

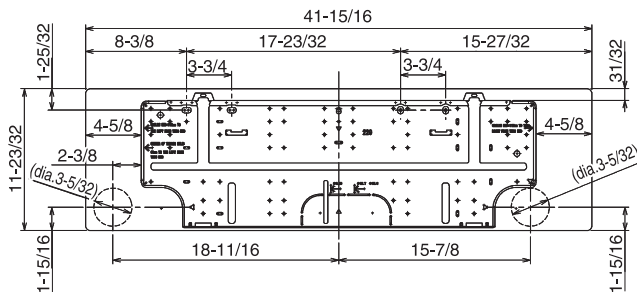
# Indoor Dimensions



Wide tube  
dia. 1/2" (12.70) ... CS-MKS18NKU  
dia. 5/8" (15.88) ... CS-MKS24NKU

Drain hose dia. 23/32" (18)

Narrow tube  
dia. 1/4" (6.35)



# INSTALLATION INSTRUCTIONS

## Split System Air Conditioner

This air conditioner uses the refrigerant R410A.

### Contents

**NOTE** External diameter of service port R410A: 5/16"

Page

#### Model Combinations

Combine indoor and outdoor units only as listed below.

**Model No.**

<u>Indoor Unit</u>	<u>Outdoor Unit</u>
CS-MKE7NKH	CU-3KE19NBU
CS-MKE9NKH	CU-4KE24NBU
CS-MKE12NKH	CU-4KE31NBU
CS-MKE18NKH	
CS-MKE24NKH	

Power Source:  
60 Hz, single-phase, 230 / 208 VAC

#### IMPORTANT!

**Please Read Before Starting** ..... 2

**1. GENERAL** ..... 4

- 1-1. Tools Required for Installation (not supplied)
- 1-2. Accessories Supplied with Unit
- 1-3. Optional Copper Tubing Kit
- 1-4. Type of Copper Tube and Insulation Material
- 1-5. Additional Materials Required for Installation

**2. INSTALLATION SITE SELECTION** ..... 5

- 2-1. Indoor Unit
- 2-2. Embedding the Tubing and Wiring

**3. HOW TO INSTALL THE INDOOR UNIT** ..... 7

- 3-1. Remove the Rear Panel from the Unit
- 3-2. Make a Hole
- 3-3. Install the Rear Panel on the Wall
- 3-4. Removing and Installing the Grille
- 3-5. Shape the Indoor Side Tubing
- 3-6. Wiring Instructions
- 3-7. Wiring Instructions for Inter-unit Connections
- 3-8. Mounting
- 3-9. Drain Hose

**4. HOW TO TEST RUN THE AIR CONDITIONER** ... 17

**5. REMOTE CONTROLLER INSTALLATION POSITION** ..... 18

- 5-1. Mounting on a Wall

**6. ADDRESS SWITCH** ..... 19

- 6-1. Address Setting of the Remote Controller

**7. CONNECTING A HOME AUTOMATION DEVICE** ..... 20

**8. INSTALLATION CHECK SHEET** ..... 20

# IMPORTANT!

## Please Read Before Starting

This air conditioning system meets strict safety and operating standards. As the installer or service person, it is an important part of your job to install or service the system so it operates safely and efficiently.

### For safe installation and trouble-free operation, you must:

- Carefully read this instruction booklet before beginning.
- Follow each installation or repair step exactly as shown.
- Observe all local, state, and national electrical codes.
- Pay close attention to all warning and caution notices given in this manual.



**WARNING**

This symbol refers to a hazard or unsafe practice which can result in severe personal injury or death.



**CAUTION**

This symbol refers to a hazard or unsafe practice which can result in personal injury or product or property damage.

### If Necessary, Get Help

These instructions are all you need for most installation sites and maintenance conditions. If you require help for a special problem, contact our sales/service outlet or your certified dealer for additional instructions.

### In Case of Improper Installation

The manufacturer shall in no way be responsible for improper installation or maintenance service, including failure to follow the instructions in this document.

---

## SPECIAL PRECAUTIONS


---

**WARNING**

### When Wiring



**ELECTRICAL SHOCK CAN CAUSE SEVERE PERSONAL INJURY OR DEATH. ONLY A QUALIFIED, EXPERIENCED ELECTRICIAN SHOULD ATTEMPT TO WIRE THIS SYSTEM.**

- Do not supply power to the unit until all wiring and tubing are completed or reconnected and checked.
- Highly dangerous electrical voltages are used in this system. Carefully refer to the wiring diagram and these instructions when wiring. Improper connections and inadequate grounding can cause **accidental injury or death**.
- **Ground the unit** following local electrical codes.
- Connect all wiring tightly. Loose wiring may cause overheating at connection points and a possible fire hazard.
- To prevent possible hazards from insulation failure,  the unit must be grounded.

### When Transporting

---

Be careful when picking up and moving the indoor and outdoor units. Get a partner to help, and bend your knees when lifting to reduce strain on your back. Sharp edges or thin aluminum fins on the air conditioner can cut your fingers.

### When Installing...

---

Select an installation location which is rigid and strong enough to support or hold the unit, and select a location for easy maintenance.

#### ...In a Ceiling or Wall

Make sure the ceiling/wall is strong enough to hold the unit's weight. It may be necessary to construct a strong wood or metal frame to provide added support.

#### ...In a Room

Properly insulate any tubing run inside a room to prevent "sweating" that can cause dripping and water damage to walls and floors.



**CAUTION**

Keep the fire alarm and the air outlet at least 1.5 m away from the unit.

### When Connecting Refrigerant Tubing

---




**WARNING**

- When performing piping work do not mix air except for specified refrigerant (R410A) in refrigeration cycle. It causes capacity down, and risk of explosion and injury due to high tension inside the refrigerant cycle.
- Refrigerant gas leakage may cause fire.
- Do not add or replace refrigerant other than specified type. It may cause product damage, burst and injury etc.
- Ventilate the room well, in the event that refrigerant gas leaks during the installation. Be careful not to allow contact of the refrigerant gas with a flame as this will cause the generation of poisonous gas.
- Do not add any refrigerant, air, or substance into the refrigeration circuit other than the designated refrigerant (R410A). Adding anything other than the specified refrigerant may cause the pressure to rise excessively in the refrigeration circuit, rupturing the circuit and causing injury or damage.
- Use all-new tubing and flare nuts to make the tubing connections. Using any previous parts (from R22-based systems) may result in damage to the equipment, and may lead to the refrigeration circuit rupturing, causing a serious accident.

- Apply refrigerant lubricant to the matching surfaces of the flare and union tubes before connecting them, then tighten the nut with a torque wrench for a leak-free connection.
- Check carefully for leaks before starting the test run.
- Do not leak refrigerant while piping work for an installation or re-installation, and while repairing refrigeration parts. Handle liquid refrigerant carefully as it may cause frost-bite.

### When Servicing

- Turn the power OFF at the main power box (mains) before opening the unit to check or repair electrical parts and wiring. 
- Keep your fingers and clothing away from any moving parts.

- Clean up the site after you finish, remembering to check that no metal scraps or bits of wiring have been left inside the unit being serviced.

### Others



**CAUTION**

- Ventilate any enclosed areas when installing or testing the refrigeration system. Escaped refrigerant gas, on contact with fire or heat, can produce dangerously toxic gas.
- Confirm upon completing installation that no refrigerant gas is leaking. If escaped gas comes in contact with a stove, gas water heater, electric room heater or other heat source, it can produce dangerously toxic gas.

### NOTE

The illustrations are based on the typical appearance of a standard model. Consequently, the shape may differ from that of the air conditioner that you are installing.

# 1. General

This booklet briefly outlines where and how to install the air conditioning system. Please read over the entire set of instructions for the indoor and outdoor units and make sure all accessory parts listed are with the system before beginning.

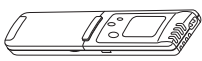




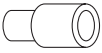

## 1-1. Tools Required for Installation (not supplied)

1. Standard screwdriver
2. Phillips head screwdriver
3. Knife or wire stripper
4. Tape measure
5. Carpenter's level

6. Sabre saw or key hole saw
7. Hacksaw
8. Core bits
9. Hammer
10. Drill
11. Tube cutter
12. Tube flaring tool
13. Torque wrench
14. Adjustable wrench
15. Reamer (for deburring)

## 1-2. Accessories Supplied with Unit

**Table 1**

Parts	Figure	Q'ty	Parts	Figure	Q'ty	Parts	Figure	Q'ty
Remote controller		1	Tapping screw		10	Clamp		1
Remote control holder		1	Rawl plug		8	Drain hose adapter		1
AAA alkaline battery		2	Packed in the indoor unit.					

## 1-3. Optional Copper Tubing Kit

Copper tubing for connecting the outdoor unit to the indoor unit is available in kits which contain the narrow and wide tubing, fittings and insulation. Consult your nearest sales outlet or air conditioning workshop.

## 1-4. Type of Copper Tube and Insulation Material

If you wish to purchase these materials separately from a local source, you will need:

1. Deoxidized annealed copper tube for refrigerant tubing as detailed in Table 2.  
Cut each tube to the appropriate lengths 1' to 1'4" (30 cm to 40 cm) to dampen vibration between units.

2. Foamed polyethylene insulation for the specified copper tubes as required to precise length of tubing. Wall thickness of the insulation should be not less than 5/16" (8 mm).
3. Use insulated copper wire for field wiring. Wire size varies with the total length of wiring. Refer to 3-6. Wiring Instructions for details.



**Check local electrical codes and regulations before obtaining wire. Also, check any specified instructions or limitations.**

**Table 2**

Model	Narrow Tube		Wide Tube	
	Outer Dia.	Thickness	Outer Dia.	Thickness
CS-MKE7NKH	1/4" (6.35 mm)	0.0314" (0.8 mm)	3/8" (9.52 mm)	0.0314" (0.8 mm)
CS-MKE9NKH	1/4" (6.35 mm)	0.0314" (0.8 mm)	3/8" (9.52 mm)	0.0314" (0.8 mm)
CS-MKE12NKH	1/4" (6.35 mm)	0.0314" (0.8 mm)	3/8" (9.52 mm)	0.0314" (0.8 mm)
CS-MKE18NKH	1/4" (6.35 mm)	0.0314" (0.8 mm)	1/2" (12.70 mm)	0.0314" (0.8 mm)
CS-MKE24NKH	1/4" (6.35 mm)	0.0314" (0.8 mm)	5/8" (15.88 mm)	0.0393" (1.0 mm)

## 1-5. Additional Materials Required for Installation

1. Refrigeration (armored) tape
2. Insulated staples or clamps for connecting wire  
(See local codes.)
3. Putty
4. Refrigeration lubricant
5. Clamps or saddles to secure refrigerant tubing

## 2. Installation Site Selection

### 2-1. Indoor Unit



#### WARNING

To prevent abnormal heat generation and the possibility of fire, do not place obstacles, enclosures and grilles in front of or surrounding the air conditioner in a way that may block air flow.

#### AVOID:

- direct sunlight.
- nearby heat sources that may affect performance of the unit.
- areas where leakage of flammable gas may be expected.
- placing or allowing any obstructions near the air conditioner inlet or outlet.
- installing in rooms that contain instant-on (rapid-start) fluorescent lamps. (These may prevent the air conditioner from receiving signals.)
- places where large amounts of oil mist exist.
- installing in locations where there are devices that generate high-frequency emissions.

#### DO:

- select an appropriate position from which every corner of the room can be uniformly cooled. (High on a wall is best.)
- select a location that will hold the weight of the unit.
- select a location where tubing and drain hose have the shortest run to the outside. (Fig. 1)
- allow room for operation and maintenance as well as unrestricted air flow around the unit. (Fig. 2)
- install the unit within the maximum elevation difference (H1, H2, H3, H4) above or below the outdoor unit and within a total tubing length (L1+L2+L3, L1+L2+L3+L4) from the outdoor unit as detailed in Table 3 and Fig. 3a.

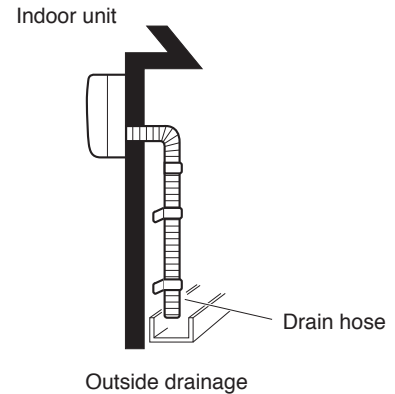
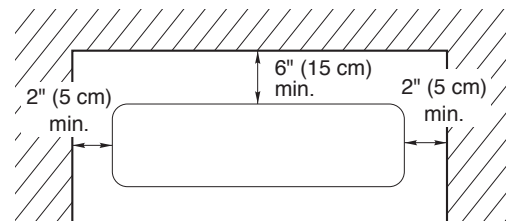


Fig. 1



Front View

Fig. 2

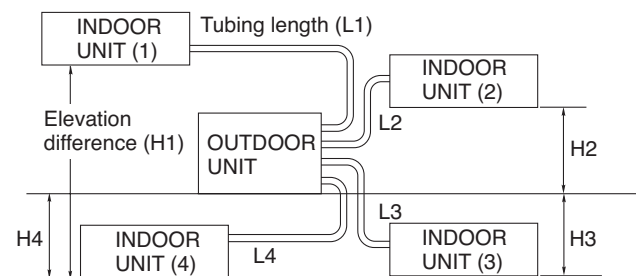


Fig. 3a



#### CAUTION

For stable operation of the air conditioner, do not install wall-mounted type indoor units less than 5' (1.5 m) from floor level.

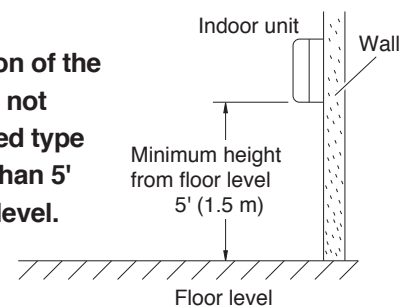


Fig. 3b

- install the indoor unit more than 3.3' (1 m) away from any antenna or power lines or connecting wires used for television, radio, telephone, security system, or intercom. Electrical noise from any of these sources may affect operation.
- install in a sturdy manner to avoid increased operating noise.

**Table 3**

Model	Max. Allowable Tubing Length Per Unit (ft.)	Max. Allowable Total Tubing Length at Shipment (L1+L2+L3) or (L1+L2+L3+L4) (ft.)	Limit of Total Tubing Length (L1+L2+L3) or (L1+L2+L3+L4) (ft.)	Limit of Elevation Difference (H1, H2, H3, H4) (ft.)	Required Amount of Additional Refrigerant (oz./ft.)*
CU-3KE19NBU	82	150 (L1+L2+L3)	150 (L1+L2+L3)	50	—
CU-4KE24NBU	82	150 (L1+L2+L3+L4)	200 (L1+L2+L3+L4)	50	0.22
CU-4KE31NBU	100	150 (L1+L2+L3+L4)	230 (L1+L2+L3+L4)	50	0.22

\* If total tubing length becomes 150 to 200 ft. (Max.) or 150 to 230 ft. (Max.), charge additional refrigerant (R410A) by 0.22 oz./ft. No additional charge of compressor oil is necessary. For more detailed charging information, refer to the Technical & Service Manual.

## 2-2. Embedding the Tubing and Wiring

- Before beginning embedding installation work, consult fully with agencies or offices related to the building's foundation, construction, electricity, and water.
- Wait to make connections to the embedded portion. Each connection step is described later in this manual.
- Securely cover the end of the embedded tubing to prevent intrusion of dirt or moisture.
- If an embedded tube is to be left for a long time, fill the tube with nitrogen and seal both ends securely. If a tube is left open for an extended time, moisture in the air inside the tubing may condense into water droplets, and lead to water contamination of the refrigerant circuit.
- In order to prevent insulation breakdown and ground faults, do not allow wiring ends to come in contact with rainwater, or be subjected to condensation or dew.
- Apply sufficient thermal insulation to the refrigerant tubing and drain pipes.

### 3. How to Install the Indoor Unit

#### 3-1. Remove the Rear Panel from the Unit

- (1) Remove and discard the set screw on the rear panel. (Fig. 6)
- (2) Press the 2  $\triangle$  marks on the frame cover and disengage the stationary tabs from the frame. (Fig. 7)
- (3) Remove the rear panel.

**NOTE**

Tubing can be extended in 5 or 6 directions as shown in Fig. 8. Select the direction you need providing the shortest run to the outside unit.

- When left tubing is to be done, switch the drain hose and drain cap. (For details, refer to “Switching drain hose and drain cap” on page 15.)

#### 3-2. Make a Hole

- (1) Place the rear panel from the indoor unit on the wall at the location selected. Make sure the panel is horizontal, using a carpenter’s level or tape measure to measure down from the ceiling. Wait until after cutting the hole before attaching the rear panel to the wall.
- (2) Determine which side of the unit you should make the hole for tubing and wiring. (Fig. 9a or 9b)

**NOTE**

In the case of left-rear tubing, use the measurement points from the edge of the rear panel for precise placement of the hose outlet. (Fig. 9a or 9b)

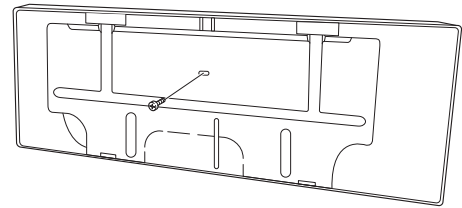
- (3) Before making the hole, check carefully that no studs or pipes are directly run behind the spot to be cut.



**CAUTION**

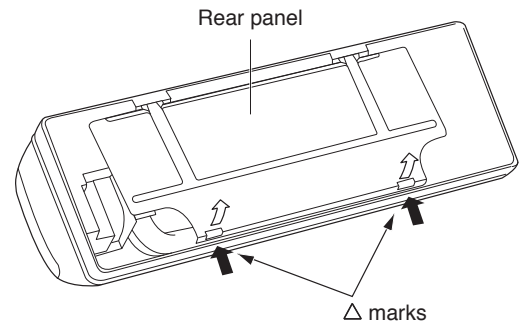
**Also avoid areas where electrical wiring or conduits are located.**

The above precautions are also applicable if tubing goes through the wall in any other location.

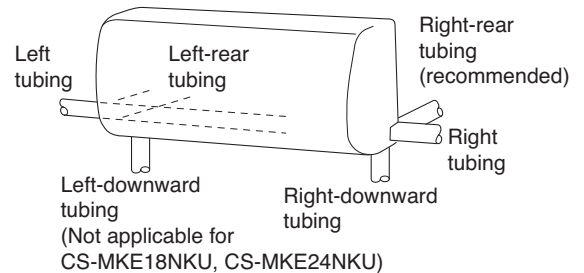


Set screw only for transportation

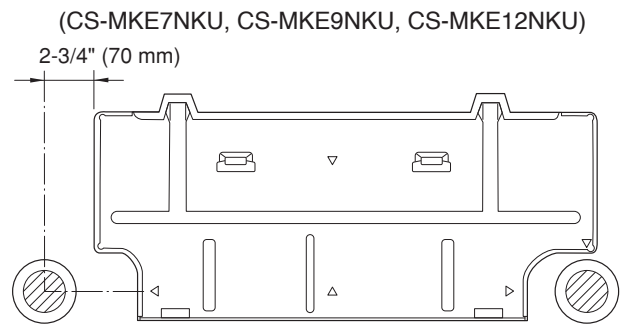
**Fig. 6**



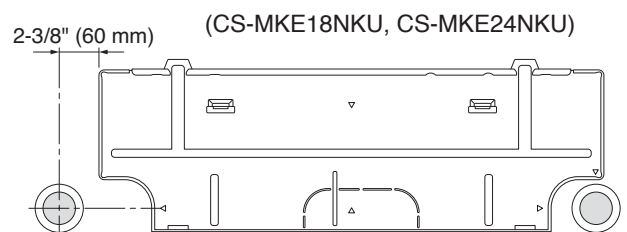
**Fig. 7**



**Fig. 8**



**Fig. 9a**



**Fig. 9b**

- (4) Using a sabre saw, key hole saw or hole-cutting drill attachment, cut a hole in the wall. See Table 4 and Fig. 10.

**Table 4**

Hole Dia.	
CS-MKE7NKU CS-MKE9NKU CS-MKE12NKU	CS-MKE18NKU CS-MKE24NKU
2-9/16" (65 mm)	3-5/32" (80 mm)

- (5) Measure the thickness of the wall from the inside edge to the outside edge and cut PVC pipe at a slight angle 1/4" (6 mm) shorter than the thickness of the wall. (Fig. 11)
- (6) Place the plastic cover over the end of the pipe (for indoor side only) and insert the pipe in the wall. (Fig. 12)

**3-3. Install the Rear Panel on the Wall**

Be sure to confirm that the wall is strong enough to suspend the unit.

See either Item a) or b) below depending on the wall type.

**a) If Wooden Wall**

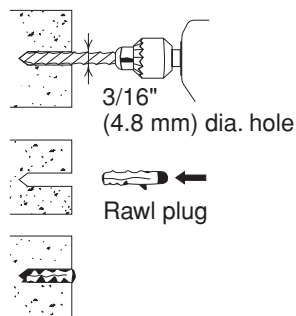
- (1) Attach the rear panel to the wall with the 8 screws provided. (Fig. 13a or 13b)

If you are not able to line up the holes in the rear panel with the beam locations marked on the wall, use rawl plugs or toggle bolts to go through the holes on the panel over the stud locations and then mount the rear panel.

- (2) Double check with a carpenter's level or tape measure that the panel is level. This is important to install the unit properly. (Fig. 14)
- (3) Make sure the panel is flush against the wall. Any space between the wall and unit will cause noise and vibration.

**b) If Block, Brick, Concrete or Similar Type Wall**

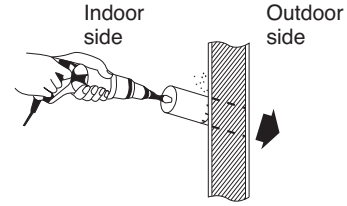
Make 3/16" (4.8 mm) dia. holes in the wall. Insert rawl plugs for appropriate mounting screws. (Fig. 15)



**Fig. 15**

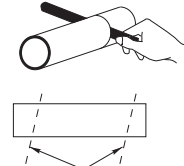
**NOTE**

Hole should be made at a slight downward slant to the outdoor side.



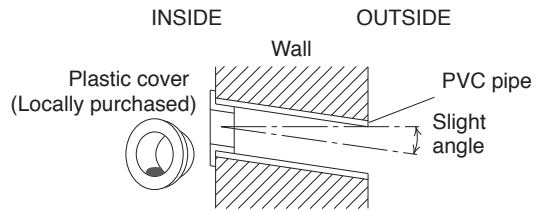
**Fig. 10**

PVC pipe (Locally purchased)



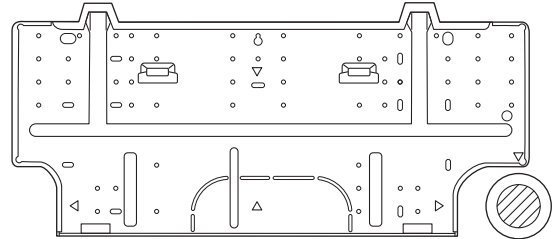
Cut at slight angle

**Fig. 11**



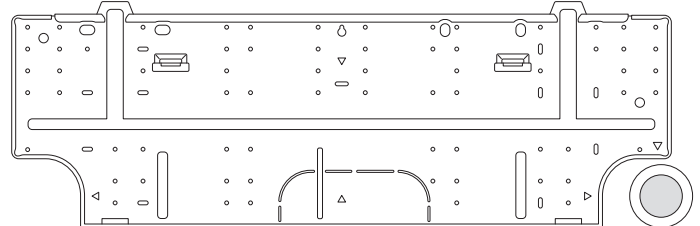
**Fig. 12**

(CS-MKE7NKU, CS-MKE9NKU, CS-MKE12NKU)

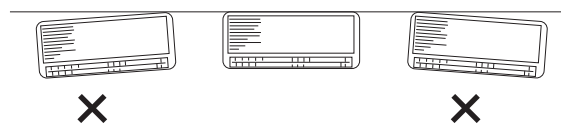


**Fig. 13a**

(CS-MKE18NKU, CS-MKE24NKU)



**Fig. 13b**



**Fig. 14**

### 3-4. Removing and Installing the Grille

#### 3-4-1. Indoor unit types

(CS-MKE7NKU, CS-MKE9NKU, CS-MKE12NKU)

Basically, these models can be installed and wired without removing the grille. If access to any internal part is needed, follow the steps as given below.



#### CAUTION

Be sure to wear work gloves during installation to avoid being cut by the sharp aluminum fins of the heat exchanger.

#### How to remove the grille

- (1) Grasp both ends of the air intake grille, and remove it by opening towards the front and pulling towards you. (Fig. 16a)
- (2) Remove the 2 screws. (Fig. 16b)
- (3) Remove the screw on the right side cover plate and open the cover. (Fig. 17a)
- (4) Take out the thermistor from the grille. (Fig. 17b)
- (5) Pull the lower part of the grille toward you to remove. (Fig. 18a)
- (6) Use a standard screwdriver to push on the tabs to remove the grille. (Fig. 18b)

#### How to replace the grille

- (1) Reinstall the grille into the lower part while aligning its tabs on the upper part. (Fig. 18b) Insert the tabs in the slots and push the lower part of the grille back into position.
- (2) Make sure that the grille and frame are firmly fitted together by engaging the tabs.
- (3) Attach the thermistor on the grille. (Fig. 17a)
- (4) Close the cover and replace the screw. (Fig. 17a)
- (5) Affix the grille with the 2 previously removed screws. (Fig. 16b)
- (6) Install the air intake grille.
  - (a) Allow the edge of the air intake grille to slide into the top of the indoor unit, and then insert it all the way inside. (Fig. 19a)
  - (b) Press the bottom right and left corners of the air intake grille to attach it to the indoor unit. (Fig. 19b)

#### NOTE

Attach so that the round pins at the top right and left corners of the air intake grille are inserted into the grooves at the top right and left of the indoor unit.

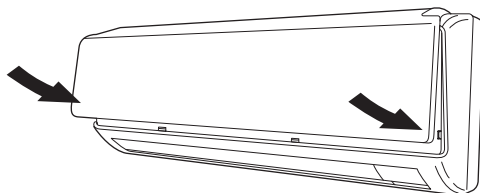


Fig. 19b

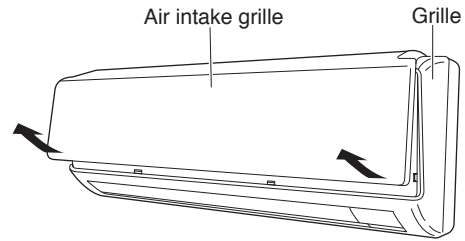


Fig. 16a

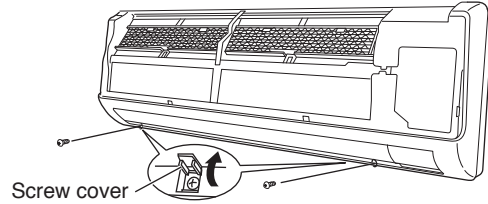


Fig. 16b

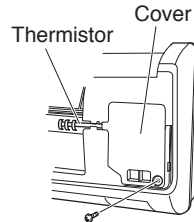


Fig. 17a

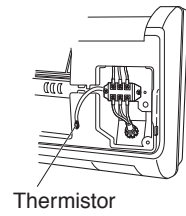


Fig. 17b

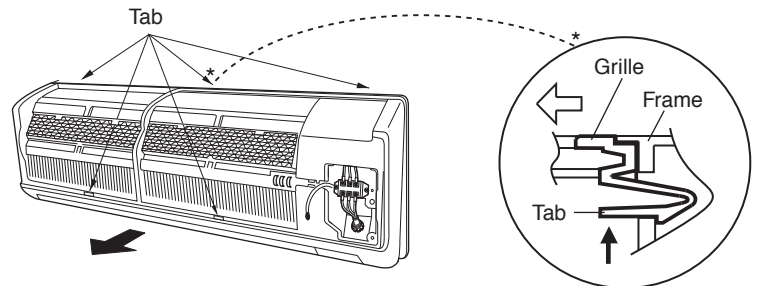


Fig. 18a

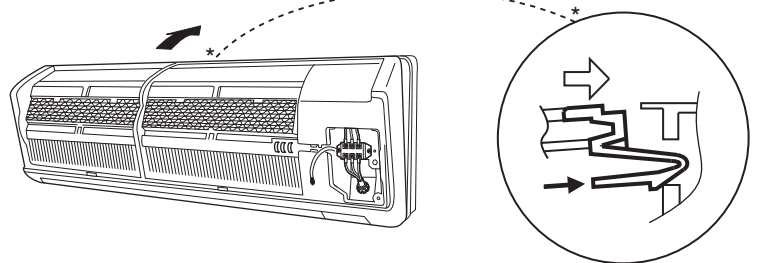


Fig. 18b

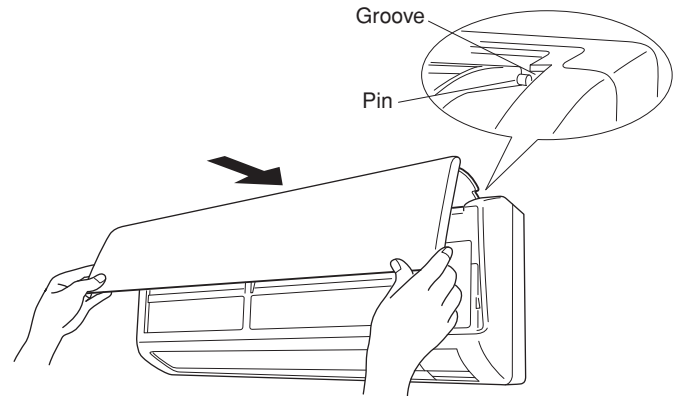


Fig. 19a

### 3-4-2. Indoor unit types (CS-MKE18NKU, CS-MKE24NKU)

Basically, these models can be installed and wired without removing the grille. If access to any internal part is needed, follow the steps as given below.

#### How to remove the grille

- (1) Grasp both ends of the air intake grille, and remove it by opening towards the front and pulling towards you. (Fig. 16a-1)
- (2) Remove the 3 screws. (Fig. 16b-1)
- (3) Remove the screw on the right side cover plate and open the cover. (Fig. 17a-1)
- (4) Take out the thermistor from the grille. (Fig. 17b-1)
- (5) Press the 3 tabs at the top of the grille and the 3 tabs on the front face to separate the grille from the frame. (Fig. 18a-1)
- (6) Pull the grill toward you to remove it.

#### How to replace the grille

- (1) When installing the grille, place the bottom of the grille into the frame first. (Fig. 18b-1)  
Then insert the tabs on the top of the grille and on the front face into the frame.
- (2) Make sure that the grille and frame are firmly fitted together by engaging the tabs.
- (3) Attach the thermistor on the grille. (Fig. 17a-1)
- (4) Close the cover and replace the screw. (Fig. 17a-1)
- (5) Affix the grille with the 3 previously removed screws. (Fig. 16b-1)
- (6) Install the air intake grille.
  - (a) Allow the edge of the air intake grille to slide into the top of the indoor unit, and then insert it all the way inside. (Fig. 19a-1)
  - (b) Press the bottom right and left corners and center of the air intake grille to attach it to the indoor unit. (Fig. 19b-1)

#### NOTE

Attach so that the round pins at the top right and left corners of the air intake grille are inserted into the grooves at the top right and left of the indoor unit.

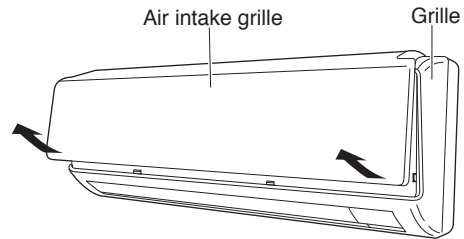


Fig. 16a-1

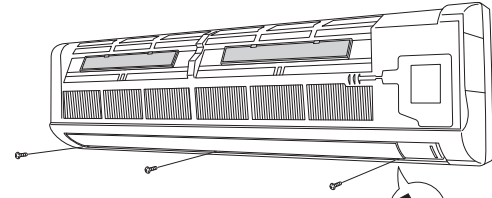


Fig. 16b-1

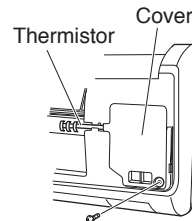


Fig. 17a-1

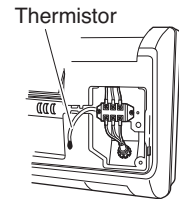


Fig. 17b-1

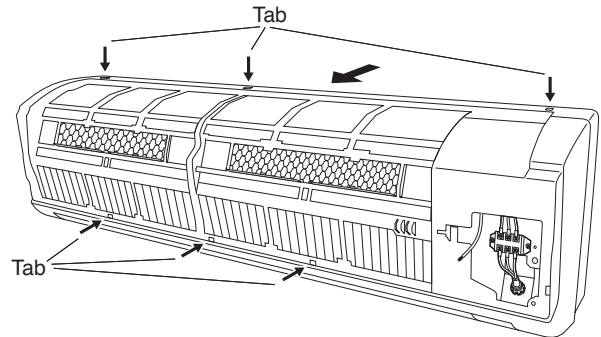


Fig. 18a-1

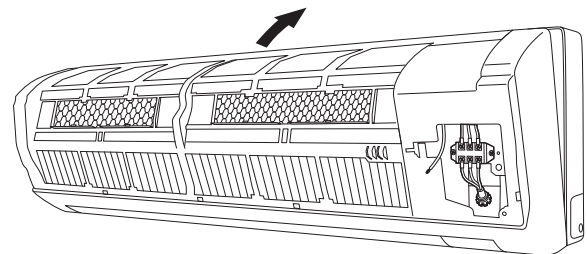


Fig. 18b-1

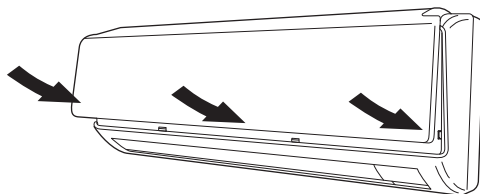


Fig. 19b-1

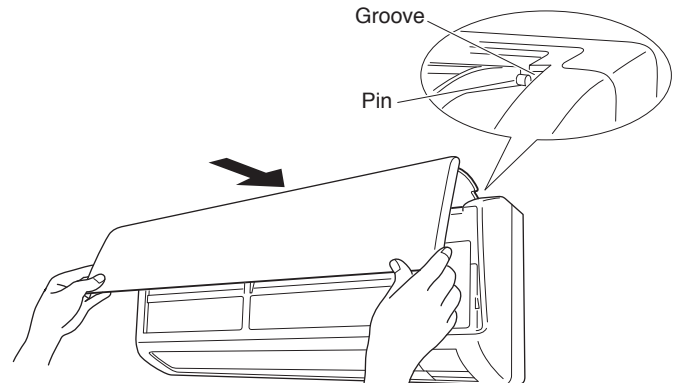


Fig. 19a-1

### 3-5. Shape the Indoor Side Tubing

#### (1) Arrangement of tubing by directions

##### a) Right or left tubing

Cut out the corner of the right/left frame with a hacksaw or the like. (Figs. 20 and 21)

##### b) Right-rear or left-rear tubing

In this case, the corner of the frame need not be cut.

#### (2) To mount the indoor unit on the rear panel:

Hang the 2 mounting slots of the unit on the upper tabs of the rear panel. (Fig. 22)

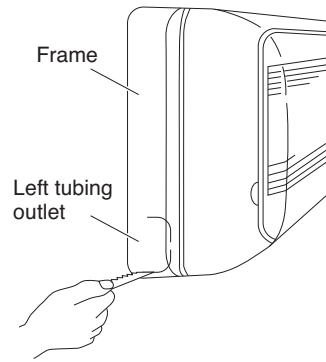


Fig. 20

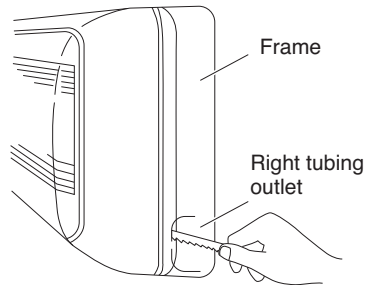


Fig. 21

### 3-6. Wiring Instructions

#### General precautions on wiring

- (1) Before wiring, confirm the rated voltage of the unit as shown on its nameplate, then carry out the wiring closely following the wiring diagram.
- (2) Provide a power outlet to be used exclusively for each unit, with a power supply disconnect and circuit breaker for overcurrent protection provided in the exclusive line.
- (3) To prevent possible hazard due to insulation failure, the unit must be grounded.
- (4) Each wiring connection must be done tightly and in accordance with the wiring system diagram. Wrong wiring may cause the unit to misoperate or become damaged.
- (5) Do not allow wiring to touch the refrigerant tubing, compressor, or any moving parts of the fan.
- (6) Unauthorized changes in the internal wiring can be very dangerous. The manufacturer will accept no responsibility for any damage or misoperation that occurs as a result of such unauthorized changes.

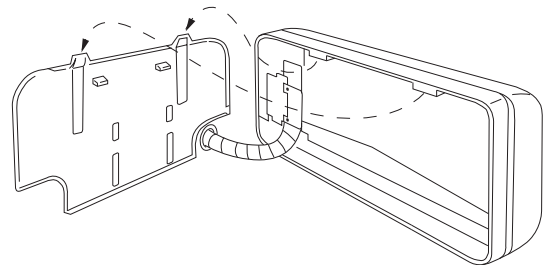


Fig. 22

### 3-7. Wiring Instructions for Inter-unit Connections

- (1) Insert the inter-unit wiring (according to local codes) into the through-the-wall PVC pipe. Run the wiring toward the indoor side allowing approx. 10" (25 cm) to extend from the wall face. (Fig. 24)
- (2) Grasp both ends of the air intake grille, and remove it by opening towards the front and pulling towards you.
- (3) Remove the screw on the right side cover plate and open the cover. (Fig. 25)
- (4) Route the inter-unit wiring from the back of the indoor unit and pull it toward the front for connection. (Figs. 26a and 26b)
- (5) Connect the inter-unit wiring to the corresponding terminals on the terminal plate (Figs. 26a and 26b) while referring to the wiring diagram.
- (6) Be sure to secure the wiring with the provided clamp.

#### NOTE

When closing the air intake grille, press the bottom right and left corners and center. (Fig. 27)

Please refer to "How to replace the grille" on page 9 or 10 for installing the air intake grille.

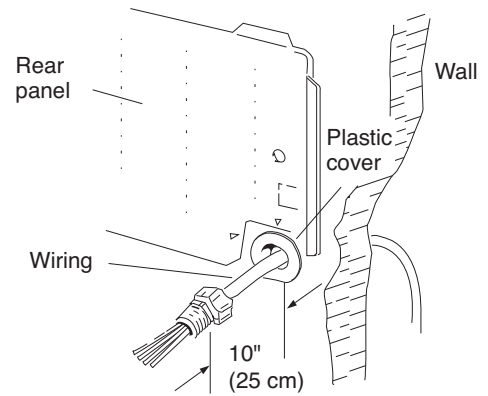


Fig. 24

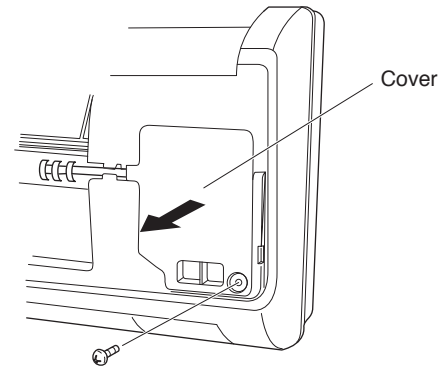


Fig. 25

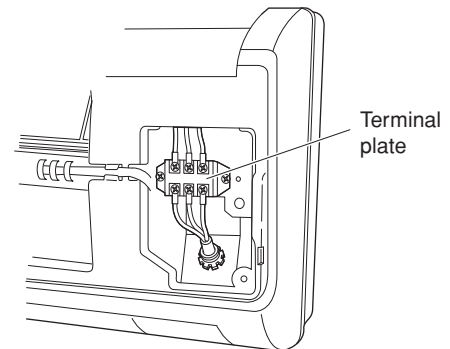


Fig. 26a

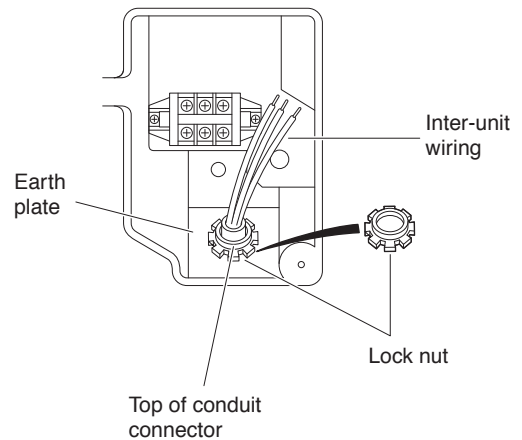


Fig. 26b

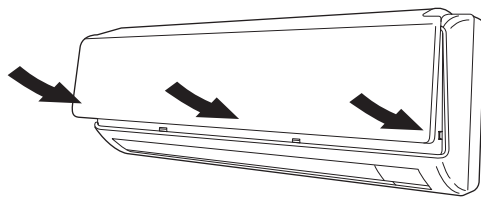


Fig. 27

**WARNING**

Loose wiring may cause the terminal to overheat or result in unit malfunction. A fire hazard may also exist. Therefore, be sure all wiring is tightly connected.

When connecting each power wire to the corresponding terminal, follow the instructions “How to connect wiring to the terminal” and fasten the wire securely tight with the fixing screw of the terminal plate.

**How to connect wiring to the terminal****a) For Indoor Unit**

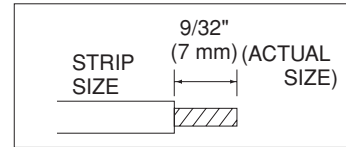
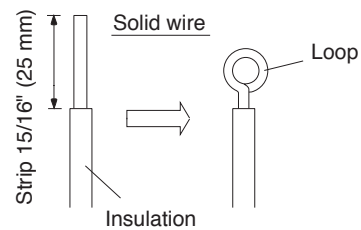
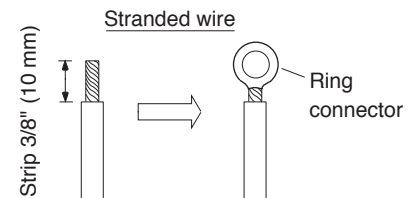
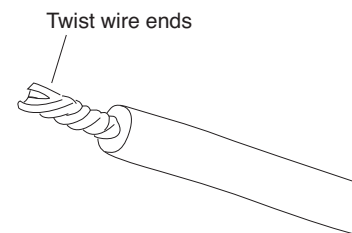
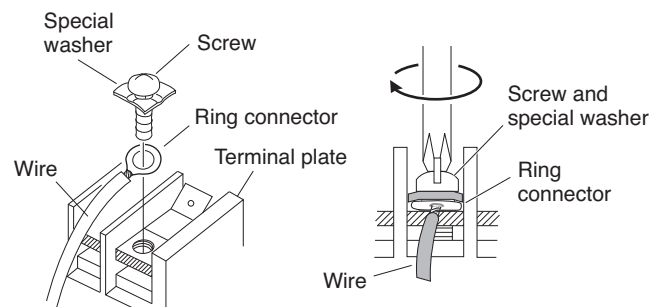
- (1) Cut the wire end with a cutting pliers, then strip the insulation to expose the wire about 9/32" (7 mm). See the label (Fig. 28) near the terminal plate.
- (2) Using a screwdriver, loosen the terminal screw on the terminal plate.
- (3) Insert the wire and tighten the terminal screw completely using a screwdriver.

**b) For Outdoor Unit****■ For solid core wiring (or F-cable)**

- (1) Cut the wire end with a cutting pliers, then strip the insulation to expose the solid wire about 15/16" (25 mm). (Fig. 29)
- (2) Using a screwdriver, remove the terminal screw(s) on the terminal plate.
- (3) Using the pliers, bend the solid wire to form a loop suitable for the terminal screw.
- (4) Shape the loop wire properly, place it on the terminal plate and fix it securely with the removed terminal screw using a screwdriver.

**■ For stranded wiring**

- (1) Cut the wire end with a cutting pliers, then strip the insulation to expose the stranded wiring about 3/8" (10 mm) and tightly twist the wire ends. (Figs. 30 and 31)
- (2) Using a screwdriver, remove the terminal screw(s) on the terminal plate.
- (3) Using a ring connector fastener or pliers, securely clamp each stripped wire end with a ring connector. (Fig. 30)
- (4) Place the ring connector wire, and replace and tighten the removed terminal screw using a screwdriver. (Fig. 32)

**Fig. 28****Fig. 29****Fig. 30****Fig. 31****Fig. 32**

### 3-8. Mounting

- (1) To install the indoor unit, mount the indoor unit onto the 2 tabs on the upper part of the rear plate.
- (2) Hold down the air discharge outlet and press the lower part of the indoor unit until it clicks to securely fasten to the 2 tabs on the lower part of the rear plate. (Fig. 33)

#### NOTE

For tubing, choose either the right or left tubing direction and follow the steps below. This work can be made easier by placing padding material (such as styrofoam) at the rear right side of the indoor unit. (Fig. 34)

#### ■ Right-side tubing

- (1) Shape the refrigerant tubing so that it can easily go into the wall hole. (Fig. 35)
- (2) Push the wiring, refrigerant tubing, and drain hose through the hole in the wall. Adjust the indoor unit so it is securely seated on the rear panel. (Fig. 36)
- (3) Carefully bend the tubing (if necessary) to run along the wall in the direction of the outdoor unit and then tape as far as the fittings. (See Caution on page 19 in the outdoor unit installation manual.) The drain hose should come straight down the wall to a point where water runoff won't stain the wall.
- (4) Connect the refrigerant tubing to the outdoor unit. (After performing a leak test on the connecting part, insulate it with the tubing insulation. (Fig. 37a)) Also, refer to Section 3-5. Tubing connections in the outdoor unit installation manual.
- (5) Assemble the refrigerant tubing, drain hose, and conduit (including inter-unit wiring) as shown in Fig. 37b.

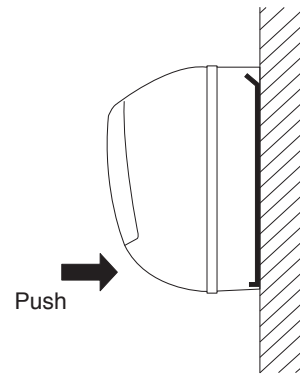


Fig. 33

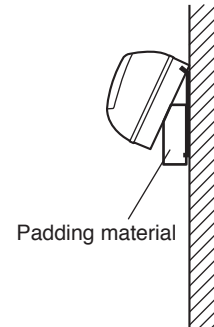


Fig. 34

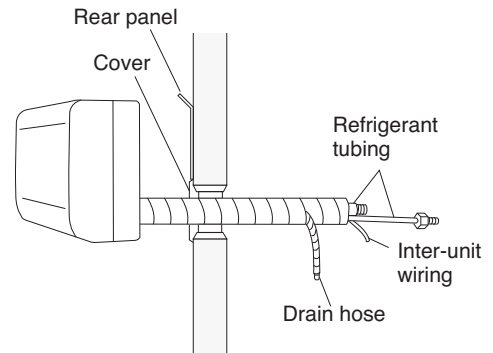


Fig. 35

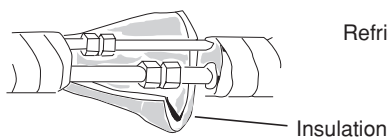


Fig. 37a

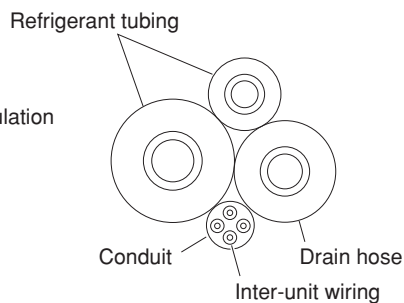


Fig. 37b

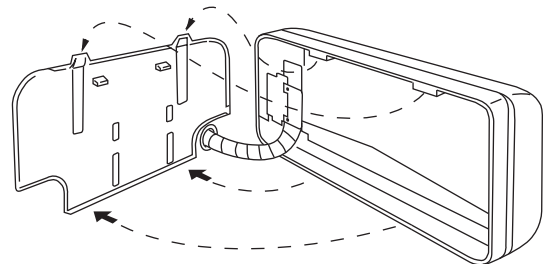


Fig. 36

## ■ Left-side tubing

- (1) Lead the tubing and drain hose through the wall, allowing sufficient length for connection. Then bend the tubing using a tube bender to make the attachment. (Fig. 38)
- (2) Switch the drain hose and drain cap.

### Switching drain hose and drain cap

- (a) Locate the drain hose and the drain cap. (Fig. 39)
- (b) Remove the screw fastening the drain hose on the right side, and pull out the drain hose to remove it. (Fig. 39)
- (c) Apply moderate force to pull off the drain cap on the left side. (If you cannot pull it off by hand, use a long-nose pliers.)
- (d) Reattach the drain hose to the left side and the drain cap to the right side. (Fig. 40a)

### Drain hose

Slide the drain hose fully onto the drain pan outlet until the drain hose edge is pushed into the insulation. Check that the screw holes in the drain bracket and the drain pan outlet are aligned and securely in contact, then fasten them with the screw. (After attaching the drain hose, check that it is attached securely.) (Fig. 40c)

### Drain cap

Use a Phillips screwdriver to push the drain cap in firmly. (If it is difficult to push in, wet the cap with water first.)

- (3) Install the indoor unit on the rear panel.
- (4) Connect the tubing and wiring led inside from outdoors.
- (5) After completing a leak test, bundle the tubing together with armoring tape and store it inside the tubing storage area at the back of the indoor unit and hold it with clamps. (Figs. 40a and 41)

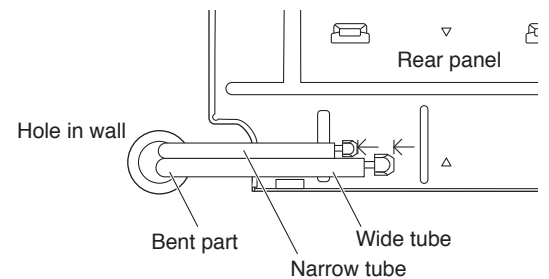


Fig. 38

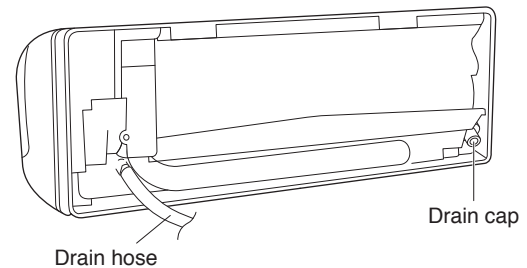


Fig. 39

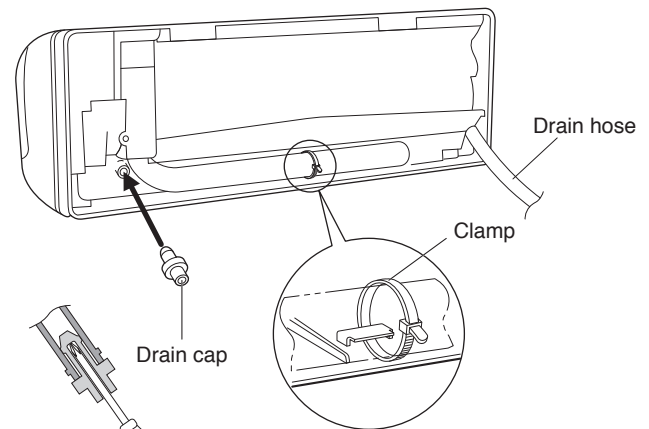


Fig. 40a

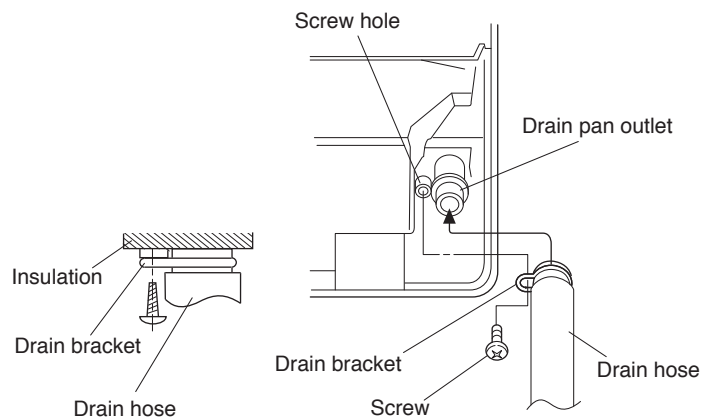


Fig. 40c

Fig. 40b

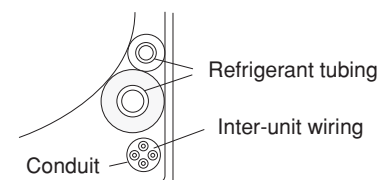


Fig. 41

## To unmount indoor unit

Press the 2 △ marks on the lower part of the indoor unit and unlatch the tabs. Then lift the indoor unit and unmount. (Fig. 42)

### 3-9. Drain Hose

- The drain hose should be slanted downward to the outdoors. (Fig. 43)
- Never form a trap in the course of the hose.
- If the drain hose will run in the room, insulate the hose with insulation\* so that chilled condensation will not damage furniture or floors. (Fig. 44)

\* Foamed polyethylene or its equivalent is recommended.

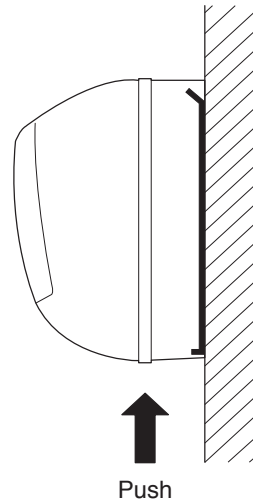


Fig. 42

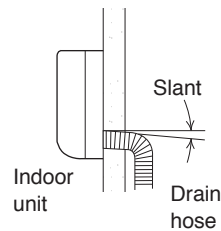


Fig. 43

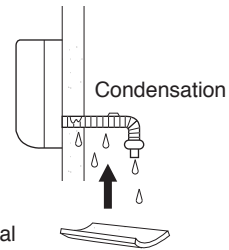




Fig. 44



**WARNING** Do not supply power to the unit or operate it until all tubing and wiring to the outside unit are completed.



**Risk of Electric Shock**

## 4. How to Test Run the Air Conditioner

After turning on the power of the air conditioner, use the remote controller and follow the steps below to conduct the test run.

- (1) Set the remote controller in Test Run mode. (Fig. 59a)
  - a) Press and hold the QUIET button and the 1HR. TIMER button.
  - b) Then press and hold the ACL (Reset) button with a pointed object such as the tip of a pen. After 5 seconds, release the ACL button first.
  - c) Then release the QUIET and 1HR. TIMER buttons.
  - d) ❄ appears and “oP-1” blinking in the remote controller clock display area. (Fig. 59b)
- (2) Start Cooling mode test run by pressing the ON/OFF operation button of the remote controller. (Fig. 59a)
  - This starts the fan producing uncooled forced air with the 3 indicator lamps (OPERATION lamp, TIMER lamp and QUIET lamp) on the main unit blinking. (Fig. 59c)
  - After 3 minutes, the system shifts into cooling operation, and cool air will start to be felt. Cooling mode test run is unaffected by the room temperature.
- (3) Press the ON/OFF operation button of the remote controller again to stop the test run. (Fig. 59a)
- (4) Finally press the ACL (Reset) button of the remote controller to release it from Test Run mode to return to normal mode. (Fig. 59a)
  - “❄” and “oP-1” will disappear from the remote controller clock display area.

### NOTE

Troubleshooting:

In the event that the green OPERATION lamp is blinking upon powering up the system, an error condition exists. In this case, refer to the self-diagnostics procedure on the inside of the front cover.

### IMPORTANT

After the test run is completed, be sure to press the ACL (Reset) button to return to normal mode. The air conditioner will not operate correctly if this is not done.

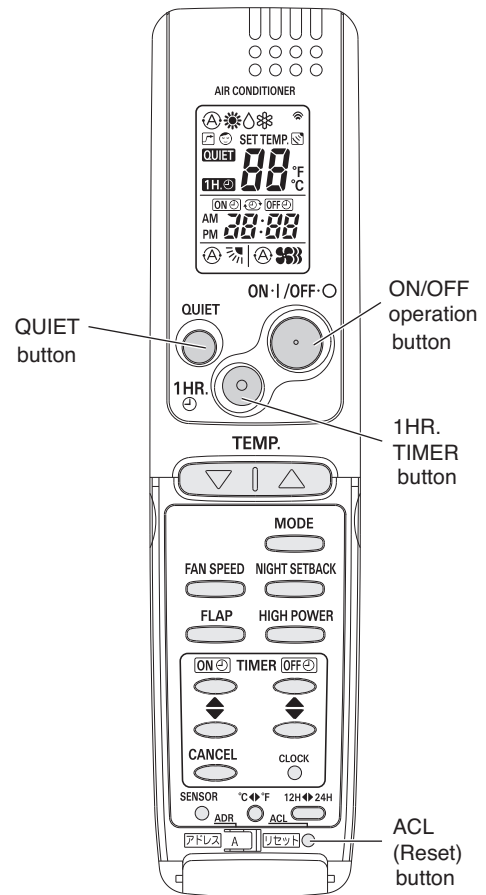


Fig. 59a

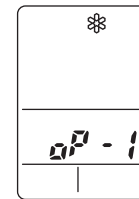


Fig. 59b

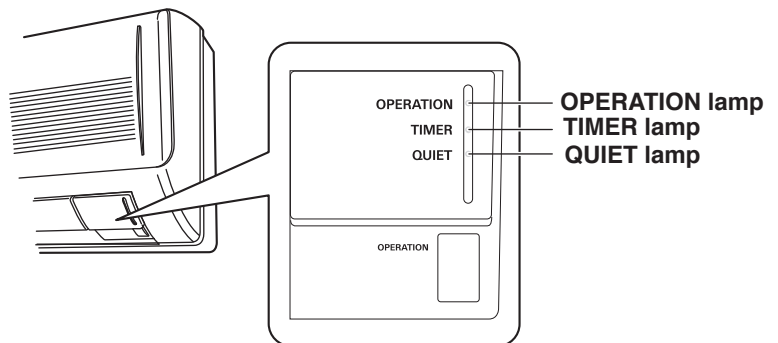


Fig. 59c

## 5. Remote Controller Installation Position

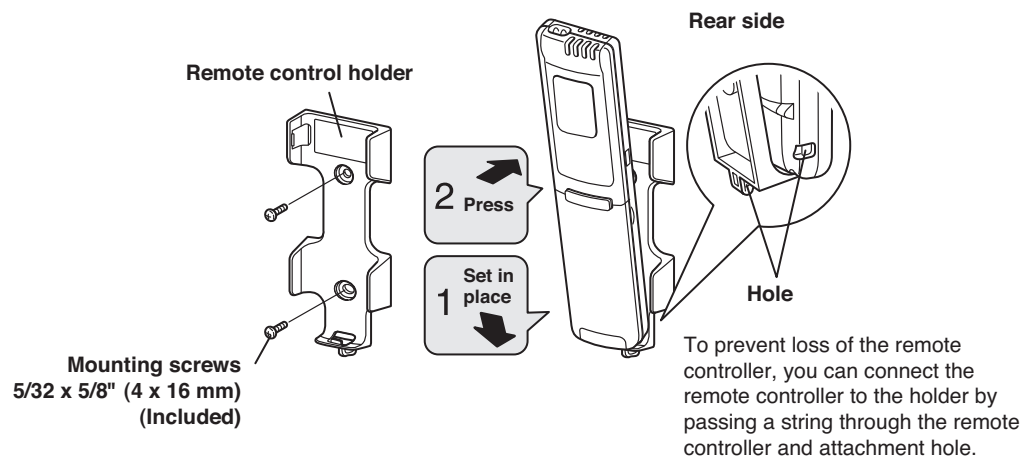
The remote controller can be operated from either a non-fixed position or a wall-mounted position.

To ensure that the air conditioner operates correctly, do not install the remote controller in the following places:

- In direct sunlight
- Behind a curtain or other place where it is covered
- More than 26' (8 m) away from the air conditioner
- In the path of the air conditioner's airstream
- Where it may become extremely hot or cold
- Where it may be subject to electrical or magnetic interference
- Where there is an obstacle between the remote controller and the air conditioner (since a check signal is sent from the remote controller every 5 minutes)

### 5-1. Mounting on a Wall

Before mounting the remote controller, press the ON/OFF operation button at the mounting location to make sure that the air conditioner operates from that location. The indoor unit should make a beeping sound to indicate that it has received the signal.



To take out the remote controller, pull it forward.

Fig. 61

## 6. Address Switch

### 6-1. Address Setting of the Remote Controller

The address can be set in order to prevent interference between remote controllers when 2 indoor units are installed near each other. The address is normally set to "A." To set a different address, it is necessary to change the address on the second remote controller.

#### NOTE

Once changed, you cannot restore the original address setting of the air conditioner.

- (1) Switch on the power source.
- (2) Break the address-setting tab marked "A" on the second remote controller to change the address (Fig. 62). When the tab is removed, the address is automatically set to B (Fig. 63).
- (3) Press and hold the remote controller QUIET button and 1HR. TIMER button. Then, press and hold the ACL (Reset) button with a pointed object such as the tip of a pen. After 5 seconds, release the ACL button first, then release the QUIET and 1HR. TIMER buttons. "oP-1" (Test Run) appears, blinking in the remote controller clock display area.
- (4) Each time the 1HR. TIMER button is pressed, the display changes as shown below. Press this button 2 times to change the display to "oP-7" (Address setting). (Fig. 64)

oP-1 Test run mode  
 ↓  
 oP-3 Selfdiagnostic mode  
 ↓  
 oP-7 Address setting mode

- (5) "oP-7" has now been selected for address setting.
- (6) Press the ON/OFF operation button on the remote controller. (Fig. 64) Check that the "beep" signal-received sound is heard from the second indoor unit (approximately 5 times). The sound you hear is the signal that the remote controller address has been changed.
- (7) Finally press the remote controller ACL (Reset) button to cancel the blinking "oP-7" display. (Fig. 64)

Changing of the second remote controller address is now completed.

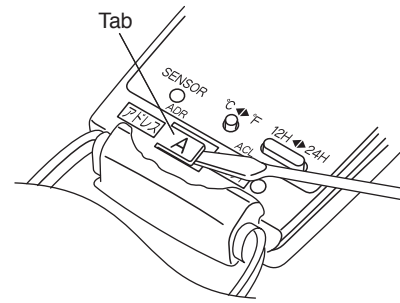


Fig. 62

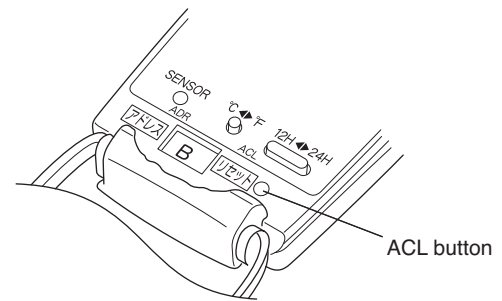


Fig. 63

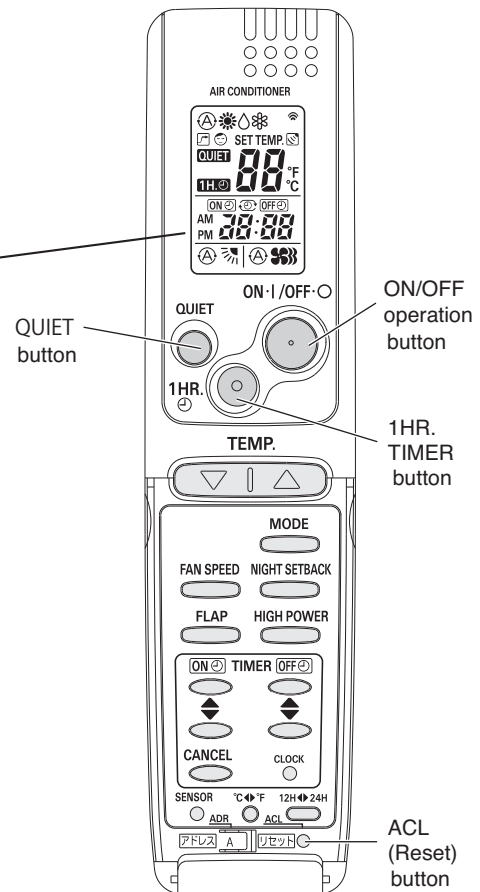


Fig. 64

## 7. Connecting a Home Automation Device

The HA (white) 4P terminal is located on the indoor unit PCB. If a HA device will be used, connect it to this terminal.

## 8. Installation Check Sheet

- The strength of the installation location is sufficient to support the air conditioner weight.
- The indoor and outdoor units are installed level and vertically.
- The power and voltage are as specified.
- Inter-unit cables are securely inserted into the terminal block.
- Inter-unit cables are securely fixed.
- The power cable and inter-unit cables are not connected anywhere along their paths.
- The ground wire is securely connected.
- Thermal insulation has been applied to the tubing connections.
- Drain connections are secure and water drains properly.
- Putty has been used to close the hole in the wall.
- Remote controller signals are being positively received.





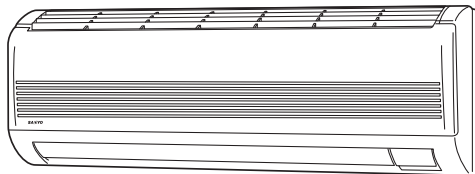
## TECHNICAL & SERVICE MANUAL

INDOOR UNIT : CS-MKE7NKU  
 CS-MKE9NKU  
 CS-MKE12NKU  
 CS-MKE18NKU  
 CS-MKE24NKU

## DC INVERTER MULTI-SYSTEM AIR CONDITIONER

Capacity	Indoor Model No.	Product Code No.
7,500BTU / h	CS-MKE7NKU	1 852 360 99
9,000BTU / h	CS-MKE9NKU	1 852 361 00
11,900BTU / h	CS-MKE12NKU	1 852 361 01
17,500BTU / h	CS-MKE18NKU	1 852 361 02
24,200BTU / h	CS-MKE24NKU	1 852 361 03

### Wall Mounted Type Indoor Unit

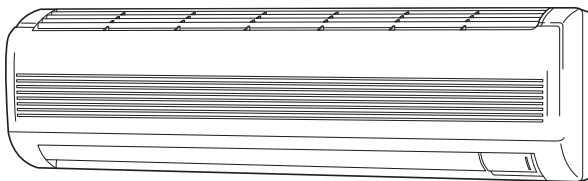


CS-MKE7NKU  
 CS-MKE9NKU  
 CS-MKE12NKU



#### < Applicable Multi-Outdoor Units >

CU-3KE19NBU (3-room multi unit)  
 CU-4KE24NBU (4-room multi unit)  
 CU-4KE31NBU (4-room multi unit)



CS-MKE18NKU  
 CS-MKE24NKU











### IMPORTANT















These air conditioners employ new refrigerant R410A.









Pay special attention when servicing the unit.













# R410A

# SAFETY PRECAUTIONS

- Before doing repair work, please read the " SAFETY PRECAUTIONS" carefully and fully understand them.
- The precautionary items here are divided into " Warning" and " Caution" items.  
Items in particular which may cause death or serious injury to the service personnel if the work is not performed correctly, are included in the " Warning" table.  
However, even precautionary items identified as " Caution" also have the potential for serious consequences if not performed correctly.  
Important safety precautions are described for all items in both categories. Be sure to carefully follow all of them.
- Symbol Indication
  -  : This symbol indicates items to which we need to pay attention.  
In this triangle, a definite precautionary item is described.
  -  : This symbol indicates the item to be prohibited.  
In or close to this circle, a prohibited item is described.
  -  : This symbol indicates the items requiring special attention or instruction.  
In or close to this circle, a prohibited item is described.
- After doing repair work, perform a test run to confirm that there are no abnormalities.  
At the same time, explain the precautions in use to the user.

 <b>Warning</b>	
Before performing an overhaul, disconnect the power plug or power cable from the unit. Performing the work with the power supplied to the unit, may cause an electric shock.	
When repair work or circuit inspection that requires power supply for the air conditioner, is to be performed, do not touch the charging section. Doing so may cause an electric shock.	 Prohibit
For the step-up capacitor attached to the electric section, perform the repair work after sufficiently discharging it. Insufficient capacitor discharge may cause an electric shock.	
Do not perform repair work on the electric sections with wet hands. Doing so may cause an electric shock.	 Prohibit
Do not start or stop the air conditioner by means of connecting or disconnecting the power plug. Doing so may cause an electric shock or fire.	 Prohibit
When conducting repair work only use components included in the parts list for the corresponding unit and perform the work with the appropriate tools. Incorrect or poor repair work may cause an electric shock or fire.	
Never modify the unit. Doing so may cause an electric shock or fire.	 Prohibit
Perform all electric work according to local applicable regulations related to electrical equipment or interior wiring regulation and make sure to use the exclusive circuit. Insufficient capacity to the electric circuit or defective arrangement results may cause an electric shock or fire.	
Make sure to replace any power cable or lead wire showing any signs of scratch or deterioration. Failure to do so may cause an electric shock, overheating or fire.	
Make sure that there is no dust on or slack in the power plug and insert fully into the socket. Dust or incomplete connections may cause an electric shock or fire.	
Do not damage or process the power cord, as it may cause an electric shock or fire.	 Prohibit
For the wiring between the indoor unit and outdoor unit, securely fix the specified cable onto the terminal plate. Poorly fixed wiring may cause a heat or fire.	
After connecting the wiring between the indoor unit and outdoor unit, attach the terminal cover securely. Incomplete attachment of the terminal cover may cause overheating or fire.	

 <b>Warning</b>	
If refrigerant gas blows off during the work, do not touch the refrigerant gas as it may cause frostbite.	 Prohibit
If refrigerant gas leaks during the work, ventilate the room. If refrigerant gas catches fire, harmful gas may be generated.	
Do not mix any gas other than the specified refrigerant gas in the refrigerating cycle. If air or other contaminants mix with the gas, pressure will become extremely high in the refrigerating cycle, which may cause a unit breakdown."	 Prohibit
When the welded section of the compressor intake or discharge pipe is to be disconnected, perform it in a well-ventilated place after sufficiently recovering the refrigerant gas. Any residue gas may jet out refrigerant or refrigerating machine oil, which may cause an injury.	
When the work is to be performed in a high place (About 2 meters or more), make sure to wear a safety helmet, gloves and safety belt. Insufficient safety gear may cause a serious injury in case of a fall.	
When the unit is to be relocated, confirm that the new installation location has sufficient strength for the weight of the unit. Insufficient strength of the installation location and incomplete installation work may cause an injury due to the unit falling.	
When the remote controller batteries are replaced, dispose of the old batteries out of the reach of children. If a child swallows a battery, make sure that the child gets immediate medical attention.	

 <b>Caution</b>	
Do not wash the air conditioner with water, as this may cause an electric shock or fire.	 Prohibit
For the repair work in places with high humidity or moisture, make sure to ground the unit. Failure to do so may cause an electric shock.	
Confirm that the component attachment position, wiring condition, soldering condition and connector connection are normal. If not, it may cause overheating or fire.	
Confirm that the temperature around the compressor is not too high, and then perform the repair work. Failure to do so may cause a burn.	
Perform welding work in a place with good ventilation. If the work is performed in a poorly ventilated area, it might cause a lack of oxygen.	
If the installation plate or attachment frame has deteriorated due to corrosion, etc., replace it. Failure to do so may cause an injury due to the unit falling.	
When the cleaning is to be performed, make sure to turn off the power and pull out the plug. Touching the fan that is rotating at high speed may result in an injury.	
When the indoor unit is to be removed, do not place it on an incline. Doing so may cause wet furniture because water left inside may trickle down.	 Prohibit
Do not hold the sharp end of the unit or the aluminum fins, as it may cause an injury to your hand or finger.	 Prohibit
After repairs, make sure to measure the insulation resistance and confirm that the value is 1 Mohm or more. Any insulation error may cause an electric shock.	
After repairs, make sure to check the drainage of the indoor unit. Inappropriate drainage may cause wet furniture and floors due to water leakage.	

# Table of Contents

	Page
<b>⚠ SAFETY PRECAUTIONS</b> .....	2
<b>TABLE OF CONTENTS</b> .....	4
<b>■ APPLICABLE MULTI-OUTDOOR UNITS</b> .....	5
<b>1. OPERATING RANGE</b> .....	6
<b>2. SPECIFICATIONS</b>	
2-1. Unit Specifications .....	7
2-2. Major Component Specifications .....	17
2-3. Other Component Specifications .....	22
<b>3. DIMENSIONAL DATA</b> .....	23
<b>4. REFRIGERANT FLOW DIAGRAM</b>	
4-1. Refrigerant Flow Diagram .....	25
<b>5. PERFORMANCE DATA</b>	
5-1. Air Throw Distance Charts .....	26
<b>6. ELECTRICAL DATA</b>	
6-1. Electric Wiring Diagrams .....	31
<b>7. FUNCTIONS</b>	
7-1. Operation Functions .....	32
7-2. Protective Functions .....	34
<b>8. TROUBLESHOOTING (BEFORE CALLING FOR SERVICE)</b>	
8-1. Precautions before Performing Inspection or Repair .....	35
8-2. Method of Self-Diagnostics .....	35
8-3. Checking the Indoor and Outdoor Units .....	38
8-4. Trouble Diagnosis of Fan Motor .....	41
8-5. Noise Malfunction and Electromagnetic Interference .....	42
<b>APPENDIX A Operating Instructions</b> .....	A-1
<b>APPENDIX B Operating Instructions</b> .....	A-2
<b>APPENDIX C INSTALLATION INSTRUCTIONS</b> .....	A-3

## ■ APPLICABLE MULTI-OUTDOOR UNITS

Multi-Outdoor Unit Indoor Unit	3-Room	4-Room	4-Room
	CU-3KE19NBU	CU-4KE24NBU	CU-4KE31NBU
CS-MKE7NKU	YES	YES	YES
CS-MKE9NKU	YES	YES	YES
CS-MKE12NKU	YES	YES	YES
CS-MKE18NKU	YES	YES	YES
CS-MKE24NKU	NO	YES	YES

# 1. OPERATING RANGE

	<b>Temperature</b>	<b>Indoor Air Intake Temp.</b>	<b>Outdoor Air Intake Temp.</b>
Cooling	Maximum	95 °F DB / 71 °F WB	115° F DB
	Minimum	67 °F DB / 57 °F WB	14° F DB
Heating	Maximum	80 °F DB / 67 °F WB	75° F DB / 65 °F WB
	Minimum	– DB / – WB	– DB / 0 °F WB

## 2. SPECIFICATIONS

### 2-1. Unit Specifications

Indoor Unit **CS-MKE7NKU**

< 230V >

<b>Type</b>		Wall Mounted Type Indoor Unit	
<b>Voltage Rating</b>		230V Single-Phase 60Hz	
<b>Performance</b>		Cooling	Heating
Capacity	BTU/h	7,500	8,500
	kW	2.20	2.50
Air Circulation (Hi/Me/Lo)		ft <sup>3</sup> /min (m <sup>3</sup> /h)	241(410) / 224(381) / 212(360) 271(460) / 241(410) / 218(370)
Moisture Removal (High)		Pints/h	2.77 -
<b>Electrical Rating</b>		Cooling	Heating
Available Voltage Range		V 187 to 253	
Running Amperes		A 0.11	0.11
Power Input		W 25	25
<b>Features</b>			
Control / Temperature Control		Microprocessor / I.C. Thermistor	
Control Unit		Wireless Remote Control Unit	
Timer		24-Hour ON or OFF Timer, 1-Hour OFF Timer	
Fan Speeds		Indoor	Auto and 3 steps
Airflow Direction (Indoor)		Horizontal	Manual
		Vertical	Auto
Air Filter		Washable, Anti-Mold	
Refrigerant		R410A	
Operation Sound	Indoor : Hi/Me/Lo/Qt*	dB-A 33 / 30 / 27 / 23	33 / 30 / 27 / 23
(*Qt = Quiet mode)			
Refrigerant Tubing Connections		Flare Type	
Refrigerant	Narrow tube	inch (mm)	1/4 (6.35)
Tube Diameter	Wide tube	inch (mm)	3/8 (9.52)
Refrigerant Tubing Kit		Optional	
<b>Dimensions &amp; Weight</b>			
Unit Dimensions	Height	inch (mm)	11-7/32 (285)
	Width	inch (mm)	32-15/32 (825)
	Depth	inch (mm)	7-7/16 (189)
Package Dimensions	Height	inch (mm)	10-19/32 (269)
	Width	inch (mm)	35-21/32 (906)
	Depth	inch (mm)	14-1/32 (356)
Weight	Net	lb. (kg)	19.8 (9.0)
	Shipping	lb. (kg)	24.3 (11.0)
Shipping Volume		cu.ft (m <sup>3</sup> )	2.82 (0.08)

DATA SUBJECT TO CHANGE WITHOUT NOTICE.

Indoor Unit **CS-MKE7NKU**

< 208V >

<b>Type</b>		Wall Mounted Type Indoor Unit	
<b>Voltage Rating</b>		208V Single-Phase 60Hz	
<b>Performance</b>		Cooling	Heating
Capacity	BTU/h	7,500	8,500
	kW	2.20	2.50
Air Circulation (Hi/Me/Lo)		ft <sup>3</sup> /min (m <sup>3</sup> /h)	241(410) / 224(381) / 212(360) 271(460) / 241(410) / 218(370)
Moisture Removal (High)		Pints/h	2.77 -
<b>Electrical Rating</b>		Cooling	Heating
Available Voltage Range		V	187 to 253
Running Amperes		A	0.12 0.12
Power Input		W	25 25
<b>Features</b>			
Control / Temperature Control		Microprocessor / I.C. Thermistor	
Control Unit		Wireless Remote Control Unit	
Timer		24-Hour ON or OFF Timer, 1-Hour OFF Timer	
Fan Speeds		Indoor	Auto and 3 steps
Airflow Direction (Indoor)		Horizontal	Manual
		Vertical	Auto
Air Filter		Washable, Anti-Mold	
Refrigerant		R410A	
Operation Sound	Indoor : Hi/Me/Lo/Qt*	dB-A	33 / 30 / 27 / 23 33 / 30 / 27 / 23
(*Qt = Quiet mode)			
Refrigerant Tubing Connections		Flare Type	
Refrigerant	Narrow tube	inch (mm)	1/4 (6.35)
Tube Diameter	Wide tube	inch (mm)	3/8 (9.52)
Refrigerant Tubing Kit		Optional	
<b>Dimensions &amp; Weight</b>			
Unit Dimensions	Height	inch (mm)	11-7/32 (285)
	Width	inch (mm)	32-15/32 (825)
	Depth	inch (mm)	7-7/16 (189)
Package Dimensions	Height	inch (mm)	10-19/32 (269)
	Width	inch (mm)	35-21/32 (906)
	Depth	inch (mm)	14-1/32 (356)
Weight	Net	lb. (kg)	19.8 (9.0)
	Shipping	lb. (kg)	24.3 (11.0)
Shipping Volume		cu.ft (m <sup>3</sup> )	2.82 (0.08)

DATA SUBJECT TO CHANGE WITHOUT NOTICE.

Indoor Unit **CS-MKE9NKU**

< 230V >

<b>Type</b>		Wall Mounted Type Indoor Unit	
<b>Voltage Rating</b>		230V Single-Phase 60Hz	
<b>Performance</b>		Cooling	Heating
Capacity	BTU/h	9,000	12,200
	kW	2.65	3.60
Air Circulation (Hi/Me/Lo)		ft <sup>3</sup> /min (m <sup>3</sup> /h)	259(440) / 241(410) / 212(360) 282(479) / 271(460) / 218(370)
Moisture Removal (High)		Pints/h	3.4 -
<b>Electrical Rating</b>		Cooling	Heating
Available Voltage Range		V	187 to 253
Running Amperes		A	0.15 0.15
Power Input		W	35 35
<b>Features</b>			
Control / Temperature Control		Microprocessor / I.C. Thermistor	
Control Unit		Wireless Remote Control Unit	
Timer		24-Hour ON or OFF Timer, 1-Hour OFF Timer	
Fan Speeds		Indoor	Auto and 3 steps
Airflow Direction (Indoor)		Horizontal	Manual
		Vertical	Auto
Air Filter		Washable, Anti-Mold	
Refrigerant		R410A	
Operation Sound	Indoor : Hi/Me/Lo/Qt*	dB-A	34 / 31 / 28 / 23 34 / 31 / 28 / 23
(*Qt = Quiet mode)			
Refrigerant Tubing Connections		Flare Type	
Refrigerant	Narrow tube	inch (mm)	1/4 (6.35)
Tube Diameter	Wide tube	inch (mm)	3/8 (9.52)
Refrigerant Tubing Kit		Optional	
<b>Dimensions &amp; Weight</b>			
Unit Dimensions	Height	inch (mm)	11-7/32 (285)
	Width	inch (mm)	32-15/32 (825)
	Depth	inch (mm)	7-7/16 (189)
Package Dimensions	Height	inch (mm)	10-19/32 (269)
	Width	inch (mm)	35-21/32 (906)
	Depth	inch (mm)	14-1/32 (356)
Weight	Net	lb. (kg)	19.8 (9.0)
	Shipping	lb. (kg)	24.3 (11.0)
Shipping Volume		cu.ft (m <sup>3</sup> )	2.82 (0.08)

DATA SUBJECT TO CHANGE WITHOUT NOTICE.

Indoor Unit **CS-MKE9NKU**

< 208V >

<b>Type</b>		Wall Mounted Type Indoor Unit	
<b>Voltage Rating</b>		208V Single-Phase 60Hz	
<b>Performance</b>		Cooling	Heating
Capacity	BTU/h	9,000	12,200
	kW	2.65	3.60
Air Circulation (Hi/Me/Lo)		ft <sup>3</sup> /min (m <sup>3</sup> /h)	259(440) / 241(410) / 212(360) 282(479) / 271(460) / 218(370)
Moisture Removal (High)		Pints/h	3.4 -
<b>Electrical Rating</b>		Cooling	Heating
Available Voltage Range		V	187 to 253
Running Amperes		A	0.17 0.17
Power Input		W	35 35
<b>Features</b>			
Control / Temperature Control		Microprocessor / I.C. Thermistor	
Control Unit		Wireless Remote Control Unit	
Timer		24-Hour ON or OFF Timer, 1-Hour OFF Timer	
Fan Speeds		Indoor	Auto and 3 steps
Airflow Direction (Indoor)		Horizontal	Manual
		Vertical	Auto
Air Filter		Washable, Anti-Mold	
Refrigerant		R410A	
Operation Sound	Indoor : Hi/Me/Lo/Qt*	dB-A	34 / 31 / 28 / 23 34 / 31 / 28 / 23
(*Qt = Quiet mode)			
Refrigerant Tubing Connections		Flare Type	
Refrigerant	Narrow tube	inch (mm)	1/4 (6.35)
Tube Diameter	Wide tube	inch (mm)	3/8 (9.52)
Refrigerant Tubing Kit		Optional	
<b>Dimensions &amp; Weight</b>			
Unit Dimensions	Height	inch (mm)	11-7/32 (285)
	Width	inch (mm)	32-15/32 (825)
	Depth	inch (mm)	7-7/16 (189)
Package Dimensions	Height	inch (mm)	10-19/32 (269)
	Width	inch (mm)	35-21/32 (906)
	Depth	inch (mm)	14-1/32 (356)
Weight	Net	lb. (kg)	19.8 (9.0)
	Shipping	lb. (kg)	24.3 (11.0)
Shipping Volume		cu.ft (m <sup>3</sup> )	2.82 (0.08)

DATA SUBJECT TO CHANGE WITHOUT NOTICE.

Indoor Unit **CS-MKE12NKU**

< 230V >

<b>Type</b>		Wall Mounted Type Indoor Unit	
<b>Voltage Rating</b>		230V Single-Phase 60Hz	
<b>Performance</b>		Cooling	Heating
Capacity	BTU/h	11,900	14,300
	kW	3.50	4.20
Air Circulation (Hi/Me/Lo)		ft <sup>3</sup> /min (m <sup>3</sup> /h)	282(479) / 259(440) / 218(370) 294(500) / 271(460) / 218(370)
Moisture Removal (High)		Pints/h	4.26 -
<b>Electrical Rating</b>		Cooling	Heating
Available Voltage Range		V	187 to 253
Running Amperes		A	0.15 0.15
Power Input		W	35 35
<b>Features</b>			
Control / Temperature Control		Microprocessor / I.C. Thermistor	
Control Unit		Wireless Remote Control Unit	
Timer		24-Hour ON or OFF Timer, 1-Hour OFF Timer	
Fan Speeds		Indoor	Auto and 3 steps
Airflow Direction (Indoor)		Horizontal	Manual
		Vertical	Auto
Air Filter		Washable, Anti-Mold	
Refrigerant		R410A	
Operation Sound	Indoor : Hi/Me/Lo/Qt*	dB-A	36 / 33 / 29 / 25 34 / 31 / 29 / 25
(*Qt = Quiet mode)			
Refrigerant Tubing Connections		Flare Type	
Refrigerant	Narrow tube	inch (mm)	1/4 (6.35)
Tube Diameter	Wide tube	inch (mm)	3/8 (9.52)
Refrigerant Tubing Kit		Optional	
<b>Dimensions &amp; Weight</b>			
Unit Dimensions	Height	inch (mm)	11-7/32 (285)
	Width	inch (mm)	32-15/32 (825)
	Depth	inch (mm)	7-7/16 (189)
Package Dimensions	Height	inch (mm)	10-19/32 (269)
	Width	inch (mm)	35-21/32 (906)
	Depth	inch (mm)	14-1/32 (356)
Weight	Net	lb. (kg)	19.8 (9.0)
	Shipping	lb. (kg)	24.3 (11.0)
Shipping Volume		cu.ft (m <sup>3</sup> )	2.82 (0.08)

DATA SUBJECT TO CHANGE WITHOUT NOTICE.

Indoor Unit **CS-MKE12NKU**

< 208V >

<b>Type</b>		Wall Mounted Type Indoor Unit	
<b>Voltage Rating</b>		208V Single-Phase 60Hz	
<b>Performance</b>		Cooling	Heating
Capacity	BTU/h	11,900	14,300
	kW	3.50	4.20
Air Circulation (Hi/Me/Lo)		ft <sup>3</sup> /min (m <sup>3</sup> /h)	282(479) / 259(440) / 218(370) 294(500) / 271(460) / 218(370)
Moisture Removal (High)		Pints/h	4.26 -
<b>Electrical Rating</b>		Cooling	Heating
Available Voltage Range		V	187 to 253
Running Amperes		A	0.17 0.17
Power Input		W	35 35
<b>Features</b>			
Control / Temperature Control		Microprocessor / I.C. Thermistor	
Control Unit		Wireless Remote Control Unit	
Timer		24-Hour ON or OFF Timer, 1-Hour OFF Timer	
Fan Speeds		Indoor	Auto and 3 steps
Airflow Direction (Indoor)		Horizontal	Manual
		Vertical	Auto
Air Filter		Washable, Anti-Mold	
Refrigerant		R410A	
Operation Sound		Indoor : Hi/Me/Lo/Qt* dB-A	36 / 33 / 29 / 25 34 / 31 / 29 / 25
(*Qt = Quiet mode)			
Refrigerant Tubing Connections		Flare Type	
Refrigerant		Narrow tube inch (mm)	1/4 (6.35)
Tube Diameter		Wide tube inch (mm)	3/8 (9.52)
Refrigerant Tubing Kit		Optional	
<b>Dimensions &amp; Weight</b>			
Unit Dimensions	Height	inch (mm)	11-7/32 (285)
	Width	inch (mm)	32-15/32 (825)
	Depth	inch (mm)	7-7/16 (189)
Package Dimensions	Height	inch (mm)	10-19/32 (269)
	Width	inch (mm)	35-21/32 (906)
	Depth	inch (mm)	14-1/32 (356)
Weight	Net	lb. (kg)	19.8 (9.0)
	Shipping	lb. (kg)	24.3 (11.0)
Shipping Volume		cu.ft (m <sup>3</sup> )	2.82 (0.08)

DATA SUBJECT TO CHANGE WITHOUT NOTICE.

Indoor Unit **CS-MKE18NKU**

< 230V >

<b>Type</b>		Wall Mounted Type Indoor Unit	
<b>Voltage Rating</b>		230V Single-Phase 60Hz	
<b>Performance</b>		Cooling	Heating
Capacity	BTU/h	17,500	20,400
	kW	5.15	6.00
Air Circulation (Hi/Me/Lo)		ft <sup>3</sup> /min (m <sup>3</sup> /h)	500(850) / 447(760) / 377(641) 500(850) / 435(739) / 377(641)
Moisture Removal (High)		Pints/h	4.89 -
<b>Electrical Rating</b>		Cooling	Heating
Available Voltage Range		V	187 to 253
Running Amperes		A	0.15 0.15
Power Input		W	35 35
<b>Features</b>			
Control / Temperature Control		Microprocessor / I.C. Thermistor	
Control Unit		Wireless Remote Control Unit	
Timer		24-Hour ON or OFF Timer, 1-Hour OFF Timer	
Fan Speeds		Indoor	Auto and 3 steps
Airflow Direction (Indoor)		Horizontal	Manual
		Vertical	Auto
Air Filter		Washable, Anti-Mold	
Refrigerant		R410A	
Operation Sound	Indoor : Hi/Me/Lo/Qt*	dB-A	41 / 38 / 34 / 28 40 / 37 / 34 / 28
(*Qt = Quiet mode)			
Refrigerant Tubing Connections		Flare Type	
Refrigerant	Narrow tube	inch (mm)	1/4 (6.35)
Tube Diameter	Wide tube	inch (mm)	1/2 (12.7)
Refrigerant Tubing Kit		Optional	
<b>Dimensions &amp; Weight</b>			
Unit Dimensions	Height	inch (mm)	11-23/32 (298)
	Width	inch (mm)	41-15/16 (1,065)
	Depth	inch (mm)	8-5/8 (219)
Package Dimensions	Height	inch (mm)	11-27/32 (301)
	Width	inch (mm)	45-1/8 (1,146)
	Depth	inch (mm)	15-5/32 (385)
Weight	Net	lb. (kg)	26.5 (12.0)
	Shipping	lb. (kg)	33.1 (15.0)
Shipping Volume		cu.ft (m <sup>3</sup> )	4.59 (0.13)

DATA SUBJECT TO CHANGE WITHOUT NOTICE.

Indoor Unit **CS-MKE18NKU**

< 208V >

<b>Type</b>		Wall Mounted Type Indoor Unit	
<b>Voltage Rating</b>		208V Single-Phase 60Hz	
<b>Performance</b>		Cooling	Heating
Capacity	BTU/h	17,500	20,400
	kW	5.15	6.00
Air Circulation (Hi/Me/Lo)		ft <sup>3</sup> /min (m <sup>3</sup> /h)	500(850) / 447(760) / 377(641) / 500(850) / 435(739) / 377(641)
Moisture Removal (High)		Pints/h	4.89 / -
<b>Electrical Rating</b>		Cooling	Heating
Available Voltage Range		V	187 to 253
Running Amperes		A	0.17 / 0.17
Power Input		W	35 / 35
<b>Features</b>			
Control / Temperature Control		Microprocessor / I.C. Thermistor	
Control Unit		Wireless Remote Control Unit	
Timer		24-Hour ON or OFF Timer, 1-Hour OFF Timer	
Fan Speeds		Indoor	Auto and 3 steps
Airflow Direction (Indoor)		Horizontal	Manual
		Vertical	Auto
Air Filter		Washable, Anti-Mold	
Refrigerant		R410A	
Operation Sound		Indoor : Hi/Me/Lo/Qt* (*Qt = Quiet mode)	dB-A / 41 / 38 / 34 / 28 / 40 / 37 / 34 / 28
Refrigerant Tubing Connections		Flare Type	
Refrigerant		Narrow tube	inch (mm) / 1/4 (6.35)
Tube Diameter		Wide tube	inch (mm) / 1/2 (12.7)
Refrigerant Tubing Kit		Optional	
<b>Dimensions &amp; Weight</b>			
Unit Dimensions		Height	inch (mm) / 11-23/32 (298)
		Width	inch (mm) / 41-15/16 (1,065)
		Depth	inch (mm) / 8-5/8 (219)
Package Dimensions		Height	inch (mm) / 11-27/32 (301)
		Width	inch (mm) / 45-1/8 (1,146)
		Depth	inch (mm) / 15-5/32 (385)
Weight		Net	lb. (kg) / 26.5 (12.0)
		Shipping	lb. (kg) / 33.1 (15.0)
Shipping Volume		cu.ft (m <sup>3</sup> )	4.59 (0.13)

DATA SUBJECT TO CHANGE WITHOUT NOTICE.

Indoor Unit **CS-MKE24NKU**

< 230V >

<b>Type</b>		Wall Mounted Type Indoor Unit	
<b>Voltage Rating</b>		230V Single-Phase 60Hz	
<b>Performance</b>		Cooling	Heating
Capacity	BTU/h	24,200	29,000
	kW	7.10	8.50
Air Circulation (Hi/Me/Lo)		ft <sup>3</sup> /min (m <sup>3</sup> /h)	541(919) / 500(850) / 435(739) / 541(919) / 488(829) / 435(739)
Moisture Removal (High)		Pints/h	4.89 / -
<b>Electrical Rating</b>		Cooling	Heating
Available Voltage Range		V	187 to 253
Running Amperes		A	0.20 / 0.20
Power Input		W	45 / 45
<b>Features</b>			
Control / Temperature Control		Microprocessor / I.C. Thermistor	
Control Unit		Wireless Remote Control Unit	
Timer		24-Hour ON or OFF Timer, 1-Hour OFF Timer	
Fan Speeds		Indoor	Auto and 3 steps
Airflow Direction (Indoor)		Horizontal	Manual
		Vertical	Auto
Air Filter		Washable, Anti-Mold	
Refrigerant		R410A	
Operation Sound	Indoor : Hi/Me/Lo/Qt*	dB-A	44 / 41 / 38 / 30 / 43 / 40 / 37 / 30
(*Qt = Quiet mode)			
Refrigerant Tubing Connections		Flare Type	
Refrigerant	Narrow tube	inch (mm)	1/4 (6.35)
Tube Diameter	Wide tube	inch (mm)	5/8 (15.88)
Refrigerant Tubing Kit		Optional	
<b>Dimensions &amp; Weight</b>			
Unit Dimensions	Height	inch (mm)	11-23/32 (298)
	Width	inch (mm)	41-15/16 (1,065)
	Depth	inch (mm)	8-5/8 (219)
Package Dimensions	Height	inch (mm)	11-27/32 (301)
	Width	inch (mm)	45-1/8 (1,146)
	Depth	inch (mm)	15-5/32 (385)
Weight	Net	lb. (kg)	26.5 (12.0)
	Shipping	lb. (kg)	33.1 (15.0)
Shipping Volume		cu.ft (m <sup>3</sup> )	4.59 (0.13)

DATA SUBJECT TO CHANGE WITHOUT NOTICE.

Indoor Unit **CS-MKE24NKU**

< 208V >

<b>Type</b>		Wall Mounted Type Indoor Unit	
<b>Voltage Rating</b>		208V Single-Phase 60Hz	
<b>Performance</b>		Cooling	Heating
Capacity	BTU/h	24,200	29,000
	kW	7.10	8.50
Air Circulation (Hi/Me/Lo)		ft <sup>3</sup> /min (m <sup>3</sup> /h)	541(919) / 500(850) / 435(739) / 541(919) / 488(829) / 435(739)
Moisture Removal (High)		Pints/h	4.89 / -
<b>Electrical Rating</b>		Cooling	Heating
Available Voltage Range		V	187 to 253
Running Amperes		A	0.22 / 0.22
Power Input		W	45 / 45
<b>Features</b>			
Control / Temperature Control		Microprocessor / I.C. Thermistor	
Control Unit		Wireless Remote Control Unit	
Timer		24-Hour ON or OFF Timer, 1-Hour OFF Timer	
Fan Speeds		Indoor	Auto and 3 steps
Airflow Direction (Indoor)		Horizontal	Manual
		Vertical	Auto
Air Filter		Washable, Anti-Mold	
Refrigerant		R410A	
Operation Sound	Indoor : Hi/Me/Lo/Qt*	dB-A	44 / 41 / 38 / 30 / 43 / 40 / 37 / 30
(*Qt = Quiet mode)			
Refrigerant Tubing Connections		Flare Type	
Refrigerant	Narrow tube	inch (mm)	1/4 (6.35)
Tube Diameter	Wide tube	inch (mm)	5/8 (15.88)
Refrigerant Tubing Kit		Optional	
<b>Dimensions &amp; Weight</b>			
Unit Dimensions	Height	inch (mm)	11-23/32 (298)
	Width	inch (mm)	41-15/16 (1,065)
	Depth	inch (mm)	8-5/8 (219)
Package Dimensions	Height	inch (mm)	11-27/32 (301)
	Width	inch (mm)	45-1/8 (1,146)
	Depth	inch (mm)	15-5/32 (385)
Weight	Net	lb. (kg)	26.5 (12.0)
	Shipping	lb. (kg)	33.1 (15.0)
Shipping Volume		cu.ft (m <sup>3</sup> )	4.59 (0.13)

DATA SUBJECT TO CHANGE WITHOUT NOTICE.

## 2-2. Major Component Specifications

### 2-2-1. Indoor Unit

Indoor Unit **CS-MKE7NKU**

<b>Control PCB</b>	
Part No.	CB-CS-MKE7NKU
Controls	Microprocessor
Control Circuit Fuse	250V 3A

<b>Fan</b>	
Type	Cross-Flow
Q'ty ... Dia. and Length	inch (mm) 1 ... D3-5/8 / L24-31/32 (D92/L634)

<b>Fan Motor</b>	
Type	DC Motor
Model ... Q'ty	SIC-41CVJ-D847-4 ... 1
No. of Poles	8
Rough Measure RPM (Cool / Heat)	1,050 / 1,100
Nominal Output	W 47
Coil Resistance	Ohm -
(Ambient Temp. 68 °F (20 °C))	
Safety Device	Internal Controller
Type	Over-Current Protection
	Yes
	Over-Heat Protection
	Yes
Run Capacitor	Micro F -
	VAC -

<b>Flap Motor</b>	
Type	Stepping Motor
Model	MP24Z3
Rating	DC 12V
Coil Resistance	Ohm Each Pair of Terminal : 400 +/- 7%
(Ambient Temp. 77 °F (25 °C))	

<b>Heat Exchanger Coil</b>	
Coil	Aluminum Plate Fin / Copper Tube
Rows	2
Fins per inch	19.5
Face Area	ft <sup>2</sup> (m <sup>2</sup> ) 2.02 (0.188)

DATA SUBJECT TO CHANGE WITHOUT NOTICE.

Indoor Unit **CS-MKE9NKU**

<b>Control PCB</b>	
Part No.	CB-CS-MKE9NKU
Controls	Microprocessor
Control Circuit Fuse	250V 3A

<b>Fan</b>	
Type	Cross-Flow
Q'ty ... Dia. and Length	inch (mm) 1 ... D3-5/8 / L24-31/32 (D92/L634)

<b>Fan Motor</b>	
Type	DC Motor
Model ... Q'ty	SIC-41CVJ-D847-4 ... 1
No. of Poles	8
Rough Measure RPM (Cool / Heat)	1,100 / 1,150
Nominal Output	W 47
Coil Resistance	Ohm -
(Ambient Temp. 68 °F (20 °C))	
Safety Device	Internal Controller
Type	Internal Controller
Over-Current Protection	Yes
Over-Heat Protection	Yes
Run Capacitor	Micro F -
	VAC -

<b>Flap Motor</b>	
Type	Stepping Motor
Model	MP24Z3
Rating	DC 12V
Coil Resistance	Ohm Each Pair of Terminal : 400 +/- 7%
(Ambient Temp. 77 °F (25 °C))	

<b>Heat Exchanger Coil</b>	
Coil	Aluminum Plate Fin / Copper Tube
Rows	2
Fins per inch	19.5
Face Area	ft <sup>2</sup> (m <sup>2</sup> ) 2.02 (0.188)

DATA SUBJECT TO CHANGE WITHOUT NOTICE.

Indoor Unit **CS-MKE12NKU**

<b>Control PCB</b>	
Part No.	CB-CS-MKE12NKU
Controls	Microprocessor
Control Circuit Fuse	250V 3A

<b>Fan</b>	
Type	Cross-Flow
Q'ty ... Dia. and Length	inch (mm) 1 ... D3-5/8 / L24-31/32 (D92/L634)

<b>Fan Motor</b>	
Type	DC Motor
Model ... Q'ty	SIC-41CVJ-D847-4 ... 1
No. of Poles	8
Rough Measure RPM (Cool / Heat)	1,200 / 1,200
Nominal Output	W 47
Coil Resistance	Ohm -
(Ambient Temp. 68 °F (20 °C))	
Safety Device	Internal Controller
Type	Internal Controller
Over-Current Protection	Yes
Over-Heat Protection	Yes
Run Capacitor	Micro F -
	VAC -

<b>Flap Motor</b>	
Type	Stepping Motor
Model	MP24Z3
Rating	DC 12V
Coil Resistance	Ohm Each Pair of Terminal : 400 +/- 7%
(Ambient Temp. 77 °F (25 °C))	

<b>Heat Exchanger Coil</b>	
Coil	Aluminum Plate Fin / Copper Tube
Rows	2
Fins per inch	19.5
Face Area	ft <sup>2</sup> (m <sup>2</sup> ) 2.02 (0.188)

DATA SUBJECT TO CHANGE WITHOUT NOTICE.

Indoor Unit **CS-MKE18NKU**

<b>Control PCB</b>	
Part No.	CB-CS-MKE18NKU
Controls	Microprocessor
Control Circuit Fuse	250V 3A

<b>Fan</b>	
Type	Cross-Flow
Q'ty ... Dia. and Length	inch (mm) 1 ... D3-5/8 / L33-9/32 (D92/L845)

<b>Fan Motor</b>	
Type	DC Motor
Model ... Q'ty	SIC-41CVJ-D847-3 ... 1
No. of Poles	8
Rough Measure RPM (Cool / Heat)	1,200 / 1,200
Nominal Output	W 30
Coil Resistance	Ohm -
(Ambient Temp. 68 °F (20 °C))	
Safety Device	Internal Controller
Type	Internal Controller
Over-Current Protection	Yes
Over-Heat Protection	Yes
Run Capacitor	Micro F -
	VAC -

<b>Flap Motor</b>	
Type	Stepping Motor
Model	MP24Z3
Rating	DC 12V
Coil Resistance	Ohm Each Pair of Terminal : 400 +/- 7%
(Ambient Temp. 77 °F (25 °C))	

<b>Heat Exchanger Coil</b>	
Coil	Aluminum Plate Fin / Copper Tube
Rows	2
Fins per inch	19.5
Face Area	ft <sup>2</sup> (m <sup>2</sup> ) 3.07 (0.285)

DATA SUBJECT TO CHANGE WITHOUT NOTICE.

Indoor Unit **CS-MKE24NKU**

<b>Control PCB</b>	
Part No.	CB-CS-MKE24NKU
Controls	Microprocessor
Control Circuit Fuse	250V 3A

<b>Fan</b>	
Type	Cross-Flow
Q'ty ... Dia. and Length	inch (mm) 1 ... D3-5/8 / L33-9/32 (D92/L845)

<b>Fan Motor</b>	
Type	DC Motor
Model ... Q'ty	SIC-41CVJ-D847-3 ... 1
No. of Poles	8
Rough Measure RPM (Cool / Heat)	1,300 / 1,300
Nominal Output	W 30
Coil Resistance	Ohm -
(Ambient Temp. 68 °F (20 °C))	
Safety Device	Internal Controller
Type	Internal Controller
Over-Current Protection	Yes
Over-Heat Protection	Yes
Run Capacitor	Micro F -
	VAC -

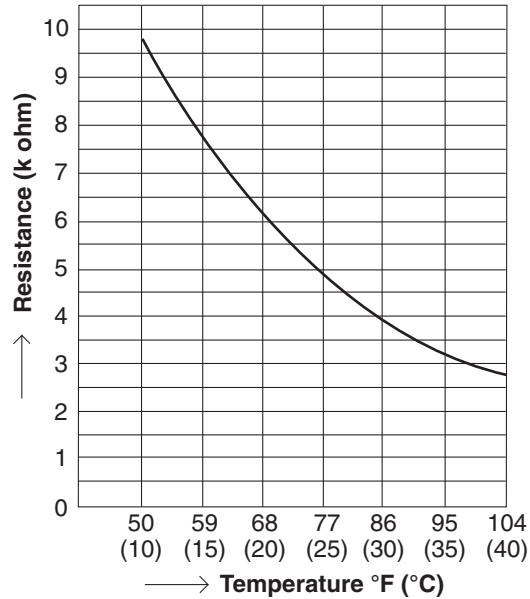
<b>Flap Motor</b>	
Type	Stepping Motor
Model	MP24Z3
Rating	DC 12V
Coil Resistance	Ohm Each Pair of Terminal : 400 +/- 7%
(Ambient Temp. 77 °F (25 °C))	

<b>Heat Exchanger Coil</b>	
Coil	Aluminum Plate Fin / Copper Tube
Rows	2
Fins per inch	19.5
Face Area	ft <sup>2</sup> (m <sup>2</sup> ) 3.07 (0.285)

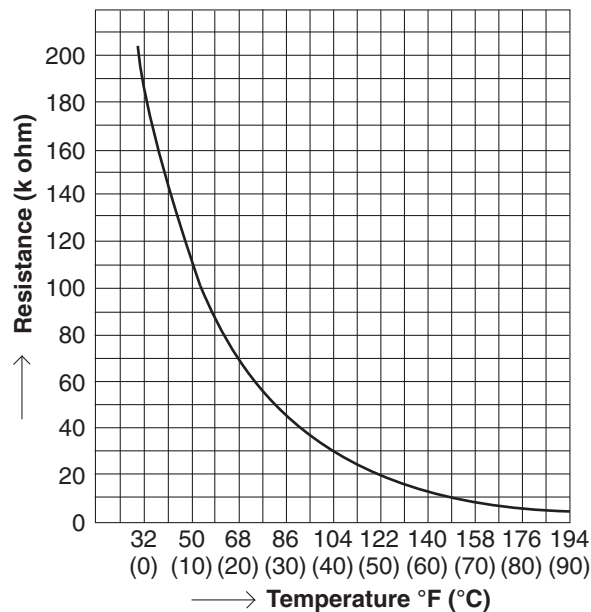
DATA SUBJECT TO CHANGE WITHOUT NOTICE.

### 2-3. Other Component Specifications

Sensor Name	Model No. of sensor	Quantity of Sensor				
		CS-MKE7NKU	CS-MKE9NKU	CS-MKE12NKU	CS-MKE18NKU	CS-MKE24NKU
Indoor air temp sensor	PTM-D51H-S4-1 TH2	1	1	1	0	0
	PTM-D51H-S4-2 TH2	0	0	0	1	1



Sensor Name	Model No. of sensor	Quantity of Sensor				
		CS-MKE7NKU	CS-MKE9NKU	CS-MKE12NKU	CS-MKE18NKU	CS-MKE24NKU
Indoor heat exchanger sensor	PTM-D51H-S4-1 TH1	1	1	1	0	0
	PTM-D51H-S4-2 TH1	0	0	0	1	1





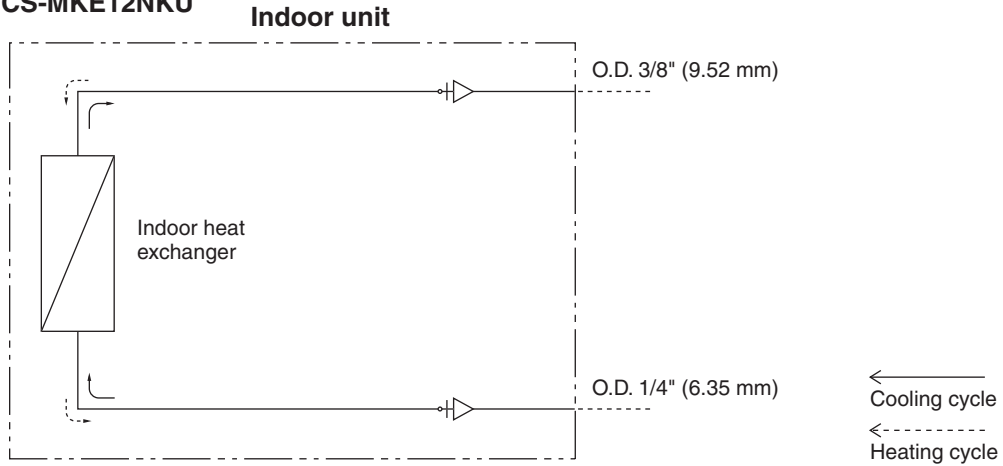


# 4. REFRIGERANT FLOW DIAGRAM

## 4-1. Refrigerant Flow Diagram

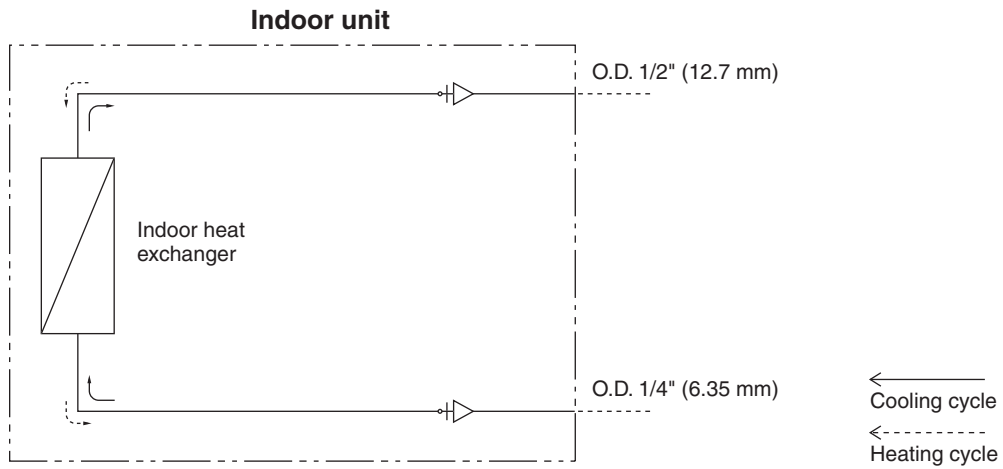
Indoor Unit

**CS-MKE7NKU**  
**CS-MKE9NKU**  
**CS-MKE12NKU**



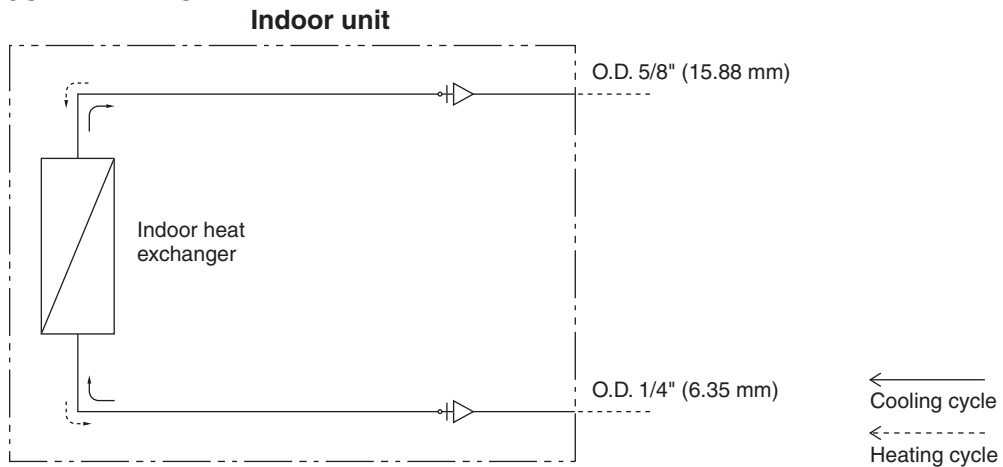
Indoor Unit

**CS-MKE18NKU**



Indoor Unit

**CS-MKE24NKU**

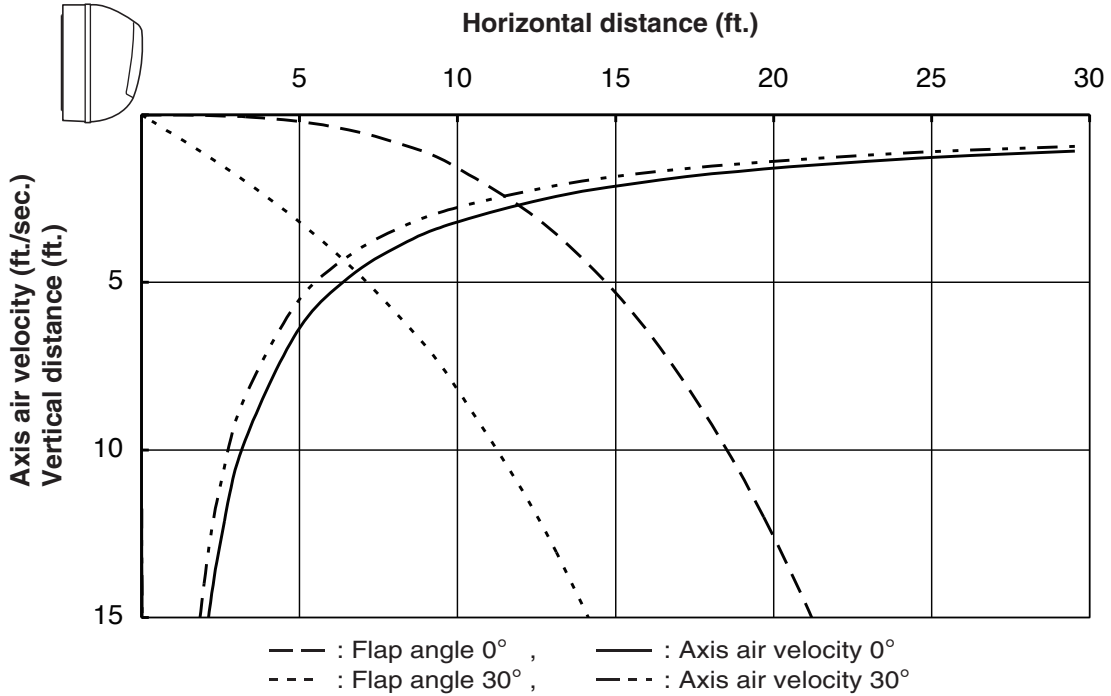


# 5. PERFORMANCE DATA

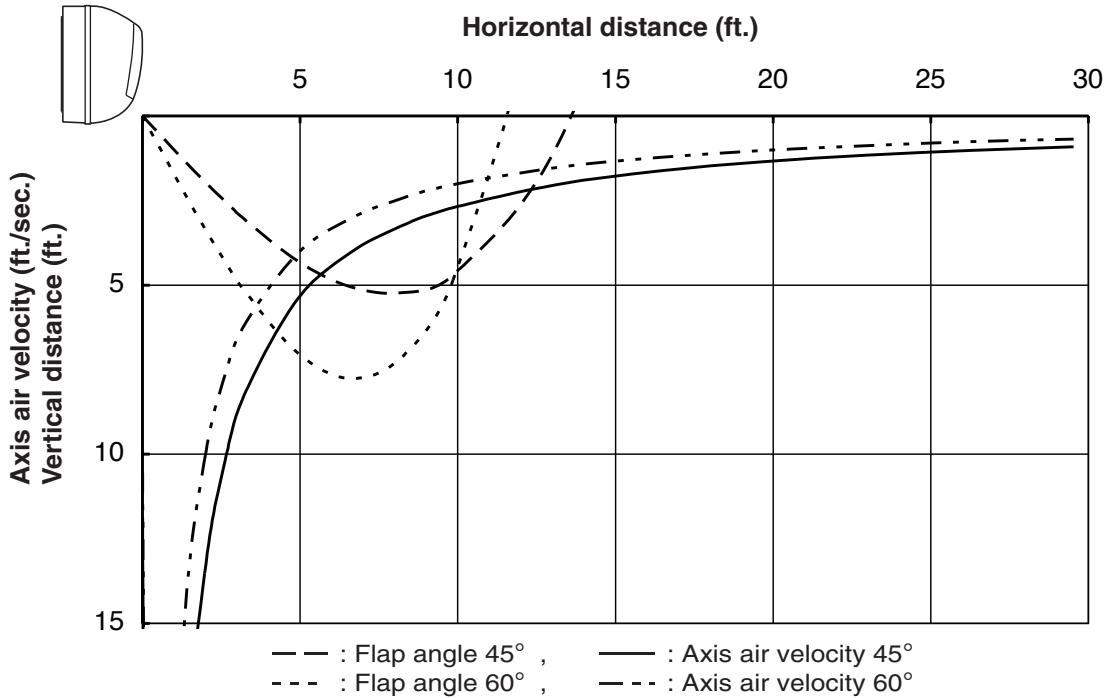
## 5-1. Air Throw Distance Charts

Indoor Unit CS-MKE7NKU

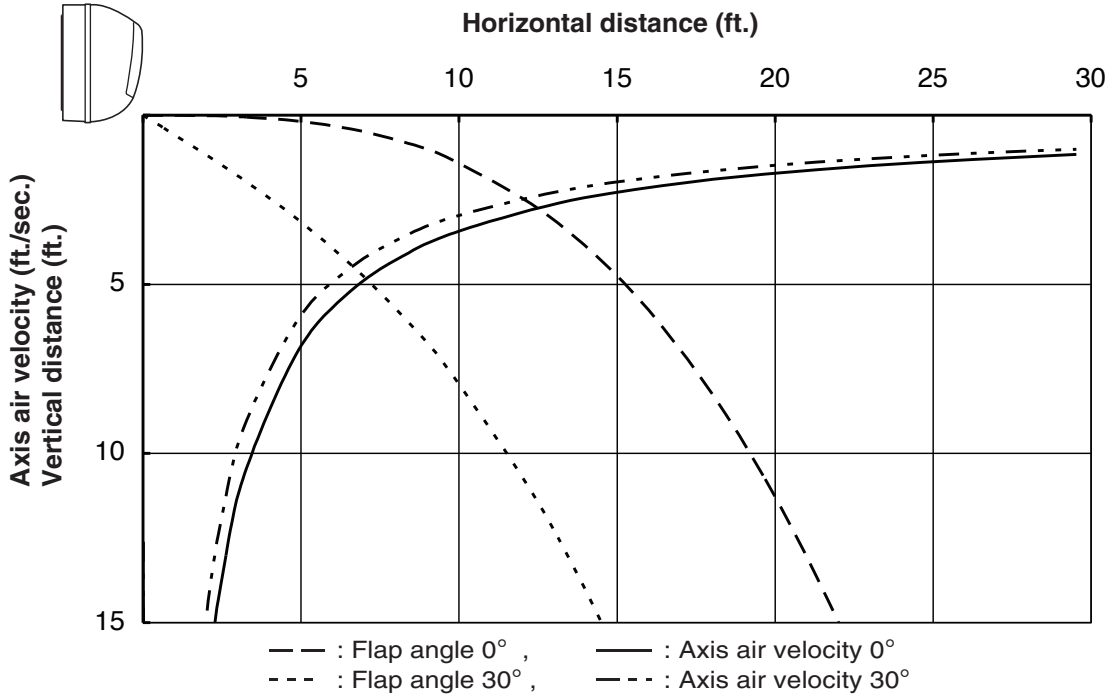
**Cooling** Room air temp.:80°F (26.7°C)  
Fan speed:High



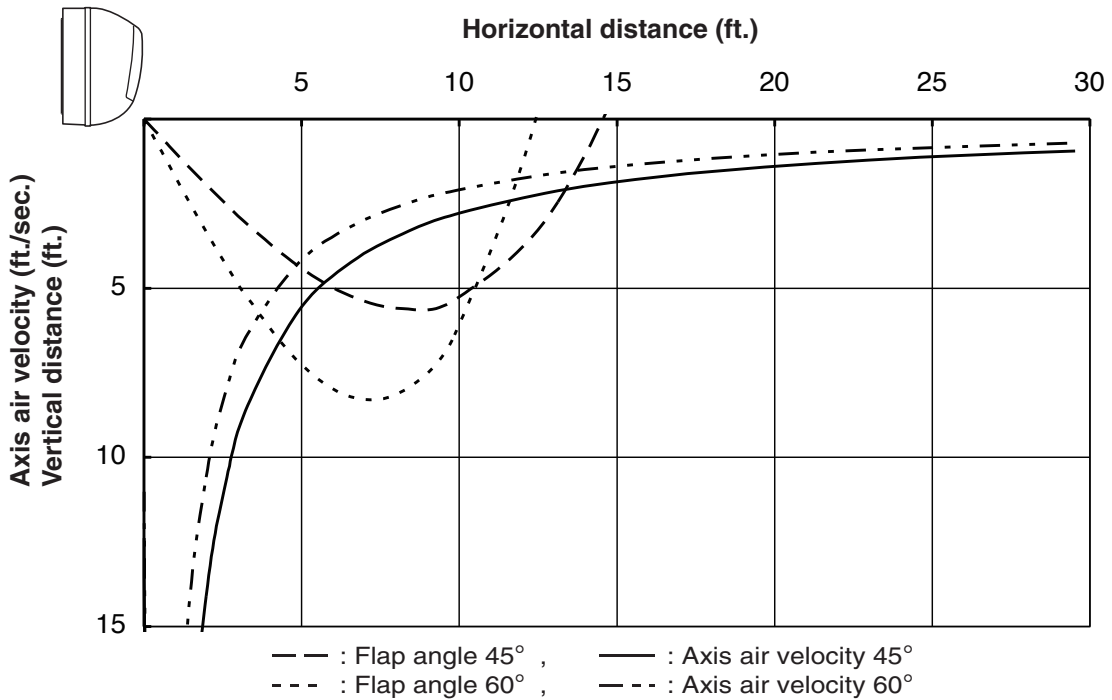
**Heating** Room air temp.:70°F (21.1°C)  
Fan speed:High



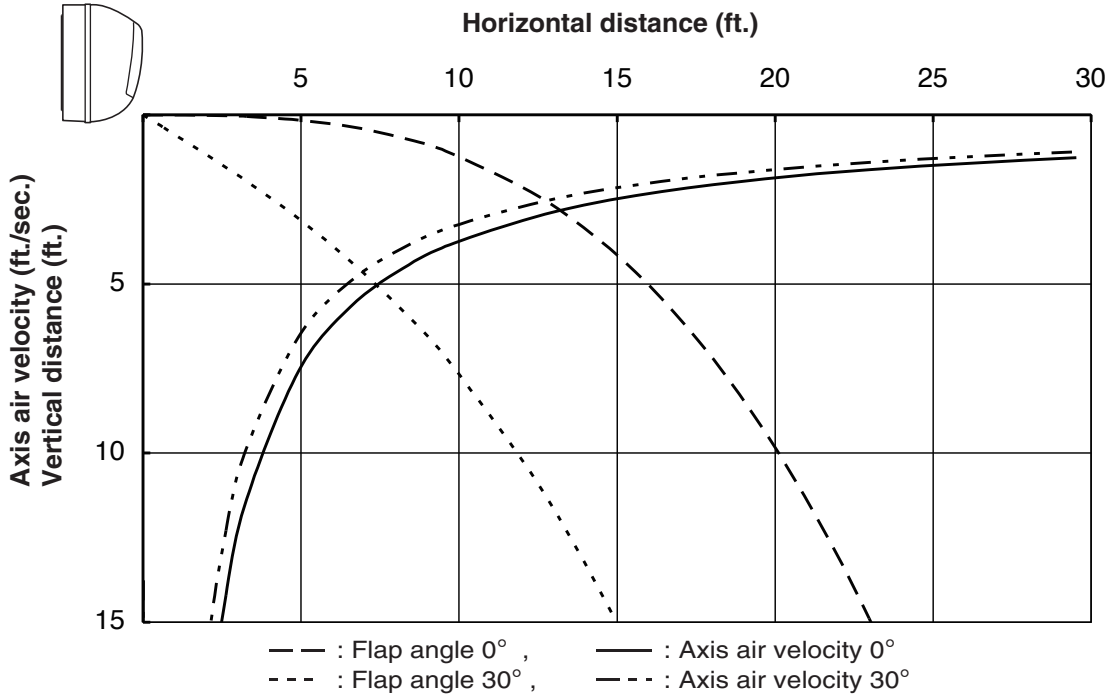
**Cooling** Room air temp.:80°F (26.7°C)  
Fan speed:High



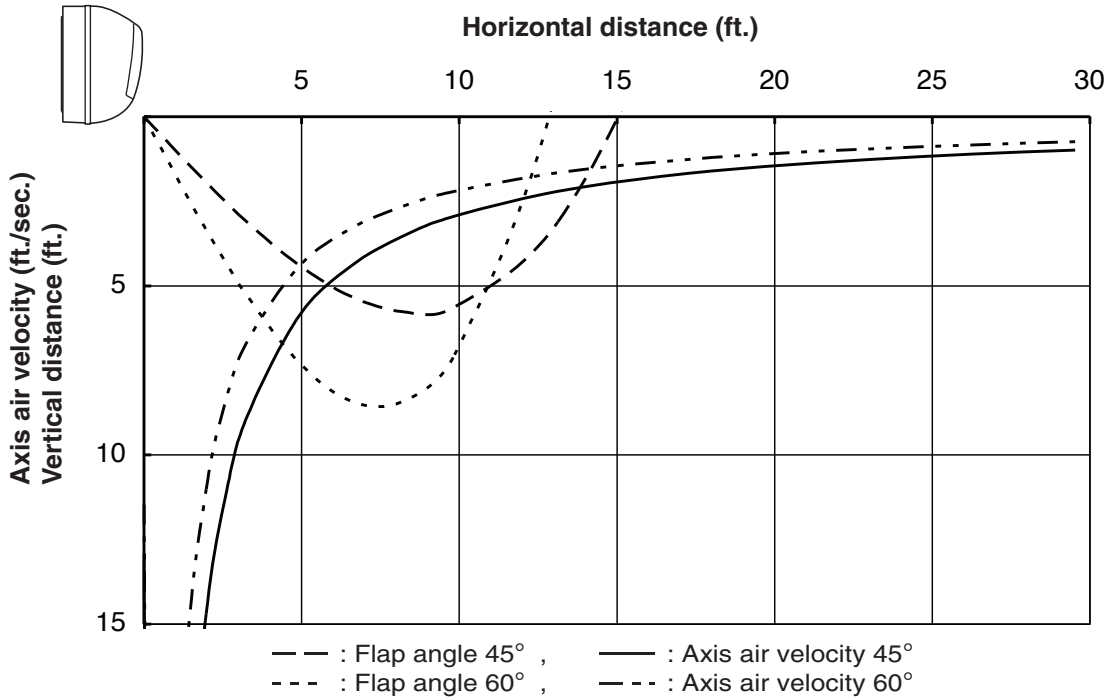
**Heating** Room air temp.:70°F (21.1°C)  
Fan speed:High



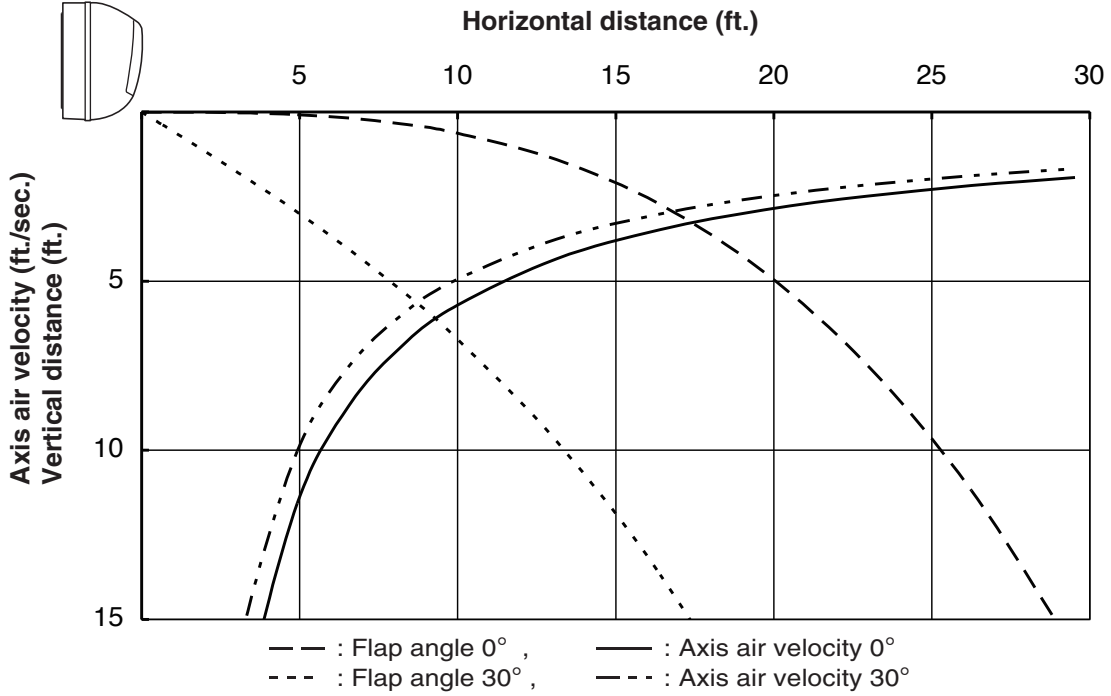
**Cooling** Room air temp.:80°F (26.7°C)  
Fan speed:High



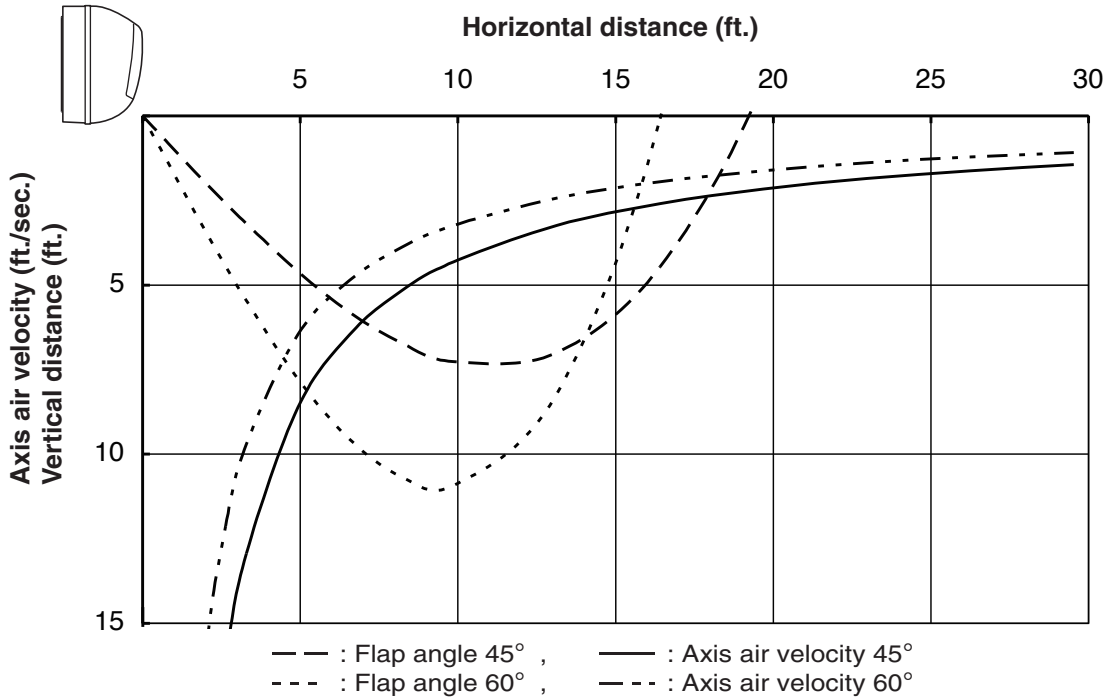
**Heating** Room air temp.:70°F (21.1°C)  
Fan speed:High



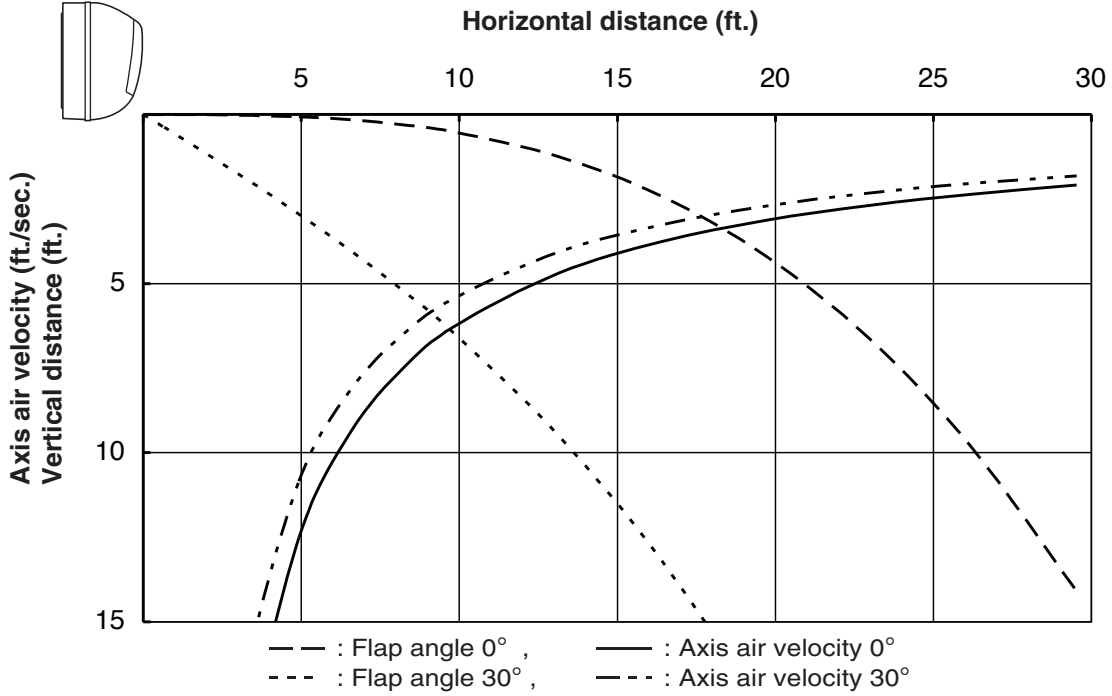
**Cooling** Room air temp.:80°F (26.7°C)  
Fan speed:High



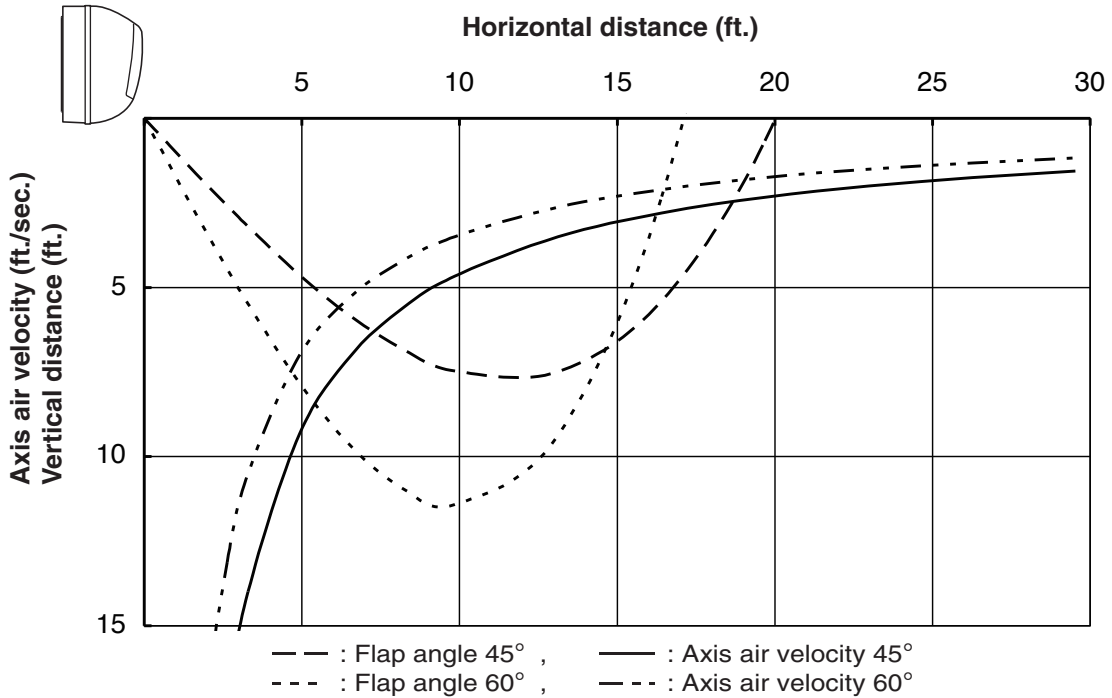
**Heating** Room air temp.:70°F (21.1°C)  
Fan speed:High



**Cooling** Room air temp.:80°F (26.7°C)  
Fan speed:High



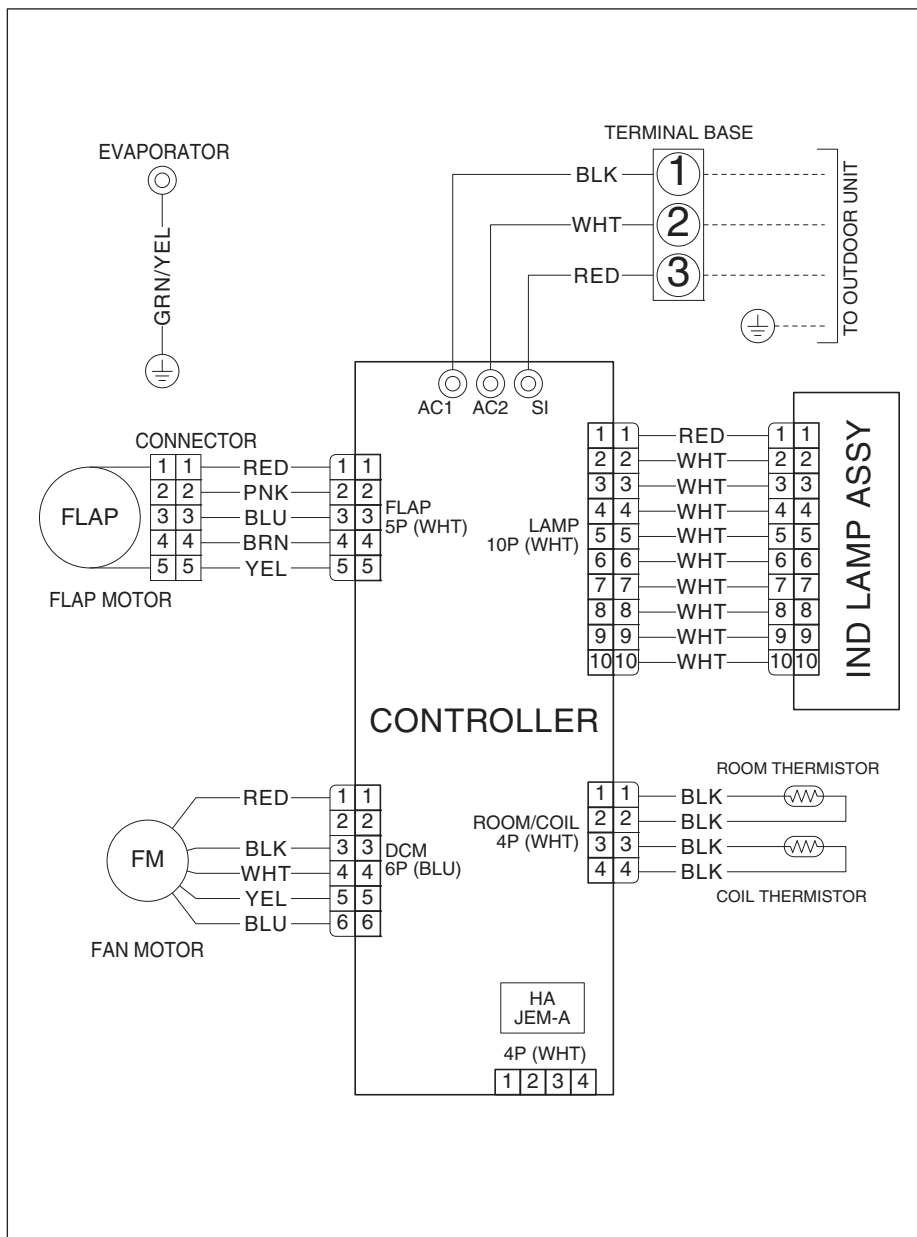
**Heating** Room air temp.:70°F (21.1°C)  
Fan speed:High



# 6. ELECTRICAL DATA

## 6-1. Electric Wiring Diagrams

Indoor Unit CS-MKE7NKU CS-MKE9NKU CS-MKE12NKU CS-MKE18NKU CS-MKE24NKU



8FA2-5251-11000-2

# 7. FUNCTIONS

## 7-1. Operation Functions

### ■ Emergency operation

**Emergency operation is available when the remote controller malfunctions, has been lost, or otherwise cannot be used.**

To operate the system, press the OPERATION button, which is also used as the receiver, below the unit display. Each time this button is pressed, the OPERATION lamp changes color to indicate the type of operation. Select the desired type of operation.



- The set temperature is 4°F(2°C) below the detected room temperature in the case of cooling operation, and 4°F(2°C) above the room temperature in the case of heating operation. The flap and fan speed settings are AUTO.

### ■ Auto Initial Operation Mode Selection

#### ● Selecting the operation mode

- When AUTO mode is selected, the microprocessor calculates the difference between the set temperature and the room temperature, and automatically switches to Cooling or Heating mode.

Room temp.  $\geq$  Set temp. → COOL  
Room temp.  $<$  Set temp. → HEAT

- Once the mode is selected based on this function, the unit will continuously operate at the same mode as initially selected.

#### NOTE

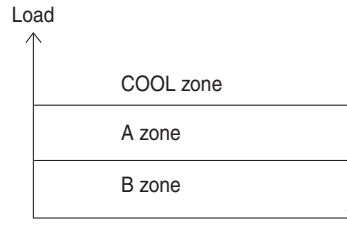
When multiple indoor units are used and units in other rooms are already operating, they will be set to the same mode of operation as the operating indoor units.

### ■ SENSOR DRY

During DRY operation, the system adjusts the room temperature and fan speed according to the conditions in the room, in order to maintain a comfortable room environment.

#### SENSOR DRY operation

- DRY operation is as shown in the figure below.



Conditions are monitored at all times when the room temperature is below 59°F(15°C).

#### DRY A

The compressor operation frequency varies.  
The indoor fan operates with 1/f fluctuation.

#### DRY B

The compressor operates at a low operating frequency.  
The indoor fan operates with 1/f fluctuation.

#### Monitor

- Monitoring operation takes place when the room temperature is below 59°F(15°C), or more than 5°F(3°C) below the set temperature.
- When the monitoring range is entered, the compressor stops, and the indoor fan operates with 1/f fluctuation.

### ■ PAM- $\alpha$ control

- In order to further improve inverter performance, control is switched between PWM control at low operation speeds, and PAM control at high operation speeds, making the most effective use of power.

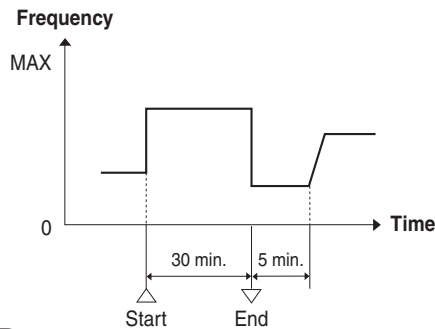
## ■ HIGH POWER

This function acts to raise the power but keeps the AC system in the same operating mode. This function is set with the HIGH POWER button on the remote controller.

(It can be set regardless of the temperature and fan speed settings.)

### ● HIGH POWER operation from remote controller

The unit operates at maximum output for 30 minutes, regardless of the desired temperature. The fan speed is 1 step above "High."



### NOTE

- When HIGH POWER operation ends, the unit operates at low Hz for 5 minutes, regardless of the thermostat OFF conditions.
- When in DRY mode, operation is in the cooling zone.

## ■ Lamp colors

### OPERATION lamp

HEAT operation	Red
DRY operation	Orange
COOL operation	Green
DEFROSTING operation	Red and Orange alternately

TIMER lamp Green

QUIET lamp Green

## ■ Timer backup

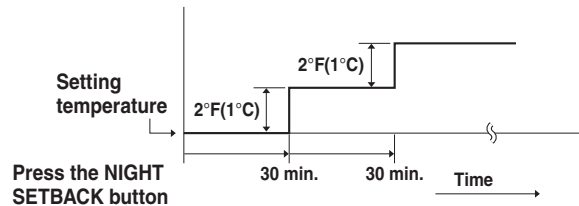
- Operation stops if there are no operator controls for 25 hours or longer after unit operation switched from OFF to ON by use of ON timer operation.

## ■ NIGHT SETBACK

- When NIGHT SETBACK operation is set, the temperature and fan speed settings will be adjusted automatically to allow comfortable sleep.
- When NIGHT SETBACK operation is set, "☺ mark" appears on the remote controller. The main unit display lamp also becomes dimmer.

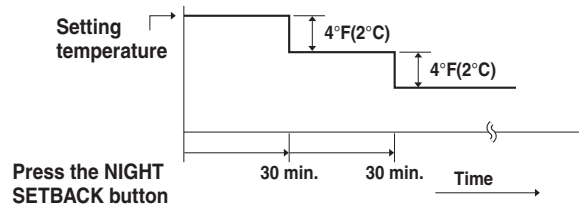
### ● COOL and DRY modes

When the night setback mode is selected, the air conditioner automatically raises the temperature setting  $2^{\circ}\text{F}(1^{\circ}\text{C})$  when 30 minutes have passed after the selection was made, and then another  $2^{\circ}\text{F}(1^{\circ}\text{C})$  after another 30 minutes have passed, regardless of the indoor temperature when night setback was selected. This enables you to save energy without sacrificing comfort. This function is convenient when gentle cooling is needed.



### ● HEAT mode

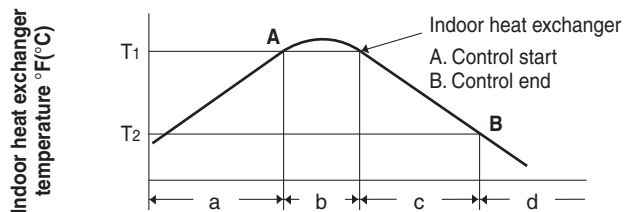
When the night setback mode is selected, the air conditioner automatically lowers the temperature setting  $4^{\circ}\text{F}(2^{\circ}\text{C})$  when 30 minutes have passed after the selection was made, and then another  $4^{\circ}\text{F}(2^{\circ}\text{C})$  after another 30 minutes have passed, regardless of the indoor temperature when night setback was selected. This enables you to save energy without sacrificing comfort. This function is convenient when gentle heating is needed.



## 7-2. Protective Functions

### Overload prevention during heating

During HEAT operation, the temperature of the indoor heat exchanger is used to control the frequency and lessen the load on the compressor before the protective device is activated.



- Area: Automatic capacity control
- When Point A has been exceeded, the operation frequency is reduced by a certain proportion.
- Area: Frequency increase is prohibited.
- At Point B and below, overload prevention is ended and control is the same as in the a area.

#### NOTE

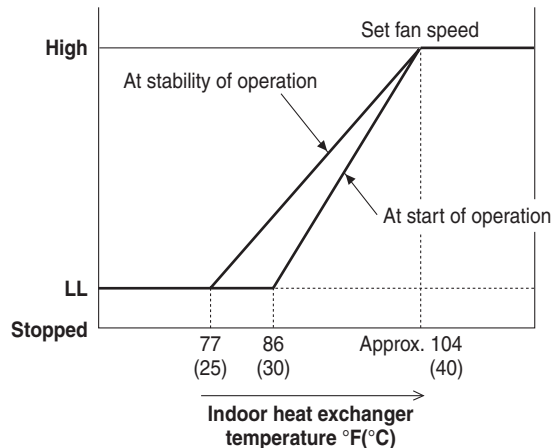
The operation temperature shown as T1 and T2 in the chart left differ by models.

	CS-KE7NKU CS-KE9NKU CS-KE12NKU	CS-KE18NKU CS-KE24NKU
T <sub>1</sub>	127(53)	124(51)
T <sub>2</sub>	117(47)	113(45)

°F(°C)

### Cold-air prevention during heating

During heating, the fan speed is set to "LL" (very low) or stopped. As the temperature of the indoor heat exchanger rises, the fan speed is changed to the set speed.



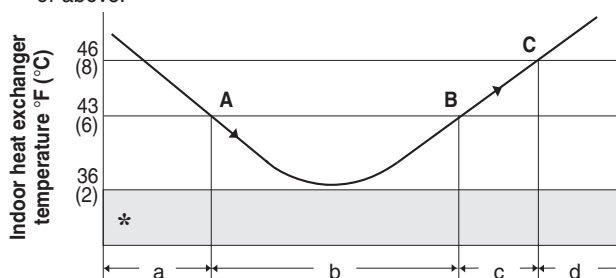
#### NOTE

- The fan speed is forcibly changed to "LL" beginning 30 seconds after the thermostat turns OFF.
- At stability of operation refers to operation when the room temperature has approached the set temperature.
- When HEAT operation starts, the indoor fan is stopped until the temperature of the indoor heat exchanger reaches 68°F(20°C) or higher, or until the room temperature reaches 59°F(15°C) or higher.

### Freeze prevention

During COOL or DRY operation, freezing is detected and operation is stopped when the temperature of the indoor heat exchanger matches the conditions below.

- Freeze-prevention operation is engaged when the temperature of the indoor heat exchanger is below 43°F(6°C).
- Restart after freeze-prevention operation occurs when the temperature of the indoor heat exchanger reaches 46°F(8°C) or above.



- Area: Automatic capacity control
- When the temperature drops below Point A, the operation frequency is reduced by a certain proportion.
- Area: Frequency increase is prohibited.
- When the temperature reaches Point C or above, freezing prevention is ended and control is the same as in the a area.

\* When the temperature drops to below 36°F(2°C) (continuously for 2 minutes or longer), the compressor stops. Once the freeze condition is detected, the air conditioner will work less than the maximum frequency until it is turned off.

# 8. TROUBLESHOOTING (BEFORE CALLING FOR SERVICE)

## 8-1. Precautions before Performing Inspection or Repair

- After checking the self-diagnostics monitor, turn the power OFF before starting inspection or repair.
  - High-capacity electrolytic capacitors are used inside the outdoor unit controller (inverter). They retain an electrical charge (charging voltage DC 310V) even after the power is turned OFF, and some time is required for the charge to dissipate. Be careful not to touch any electrified parts before the controller LED (red) turns OFF.
- If the outdoor controller is normal, approximately 30 seconds will be required for the charge to dissipate. However, allow at least 5 minutes for the charge to dissipate if there is thought to be any trouble with the outdoor controller.

## 8-2. Method of Self-Diagnostics

Follow the procedure below to perform detailed trouble diagnostics.

### NOTE

- 1: If the operation lamp blinks every 0.5 seconds immediately when the power is turned ON, there is an external ROM (OTP data) failure on the indoor circuit board, or a ROM socket insertion problem, or the ROM has not been installed.
- 2: The failure mode is stored in memory even when the power is not ON. Follow the procedure below to perform diagnostics.

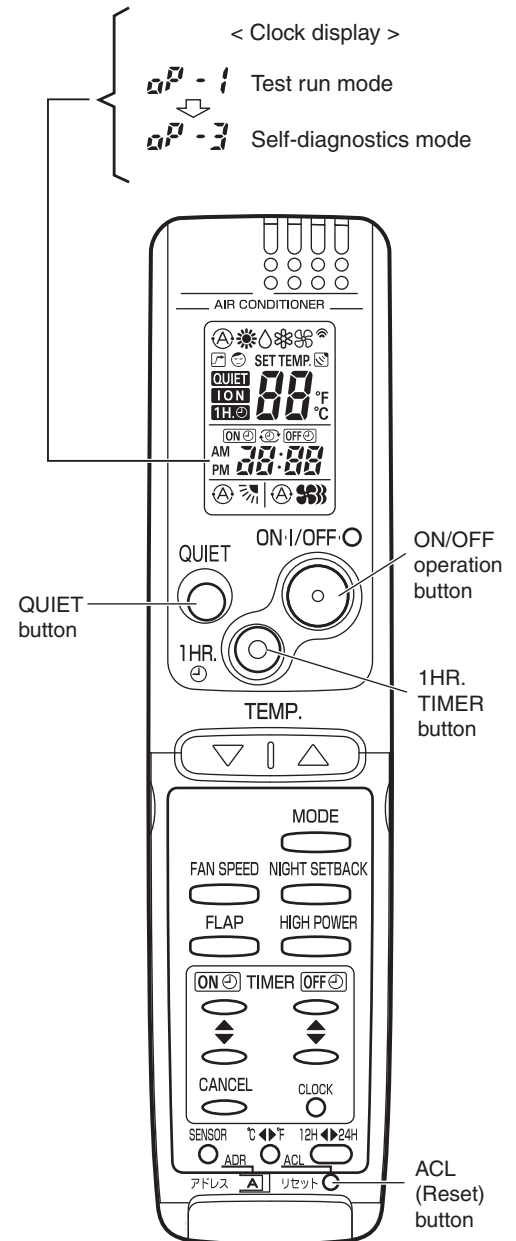
### PROCEDURE

After turning on power to the air conditioner, use the remote controller and follow the steps below to execute self-diagnostics.

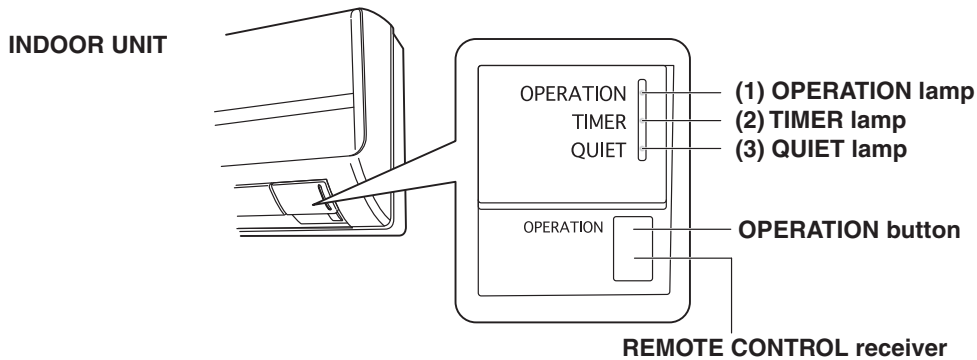
- Step 1: Press and hold the remote controller QUIET button and 1 HR TIMER button. At the same time, press the ACL (reset) button. Use a pointed object such as the tip of a pen to press the ACL button. When this has been done, "oP-1" (test run) appears, blinking, in the remote controller clock display area.
- Step 2: Next, press the 1 HR TIMER button once to change the display from "oP-1" to "oP-3" (self-diagnostics). (The display continues to blink.)
- Step 3: Finally press the ON/OFF button to engage self-diagnostics mode.

- The self-diagnostics function utilizes the 3 indicator lamps on the main unit, in combinations of ON lamps, blinking lamps, and OFF lamps, to report the existence of sensor trouble or a protective operation. (The lamps blink or remain ON for 5 seconds, then turn OFF for 2 seconds.) Self-diagnostics is completed when the buzzer sounds 3 short beeps.
- A maximum of 3 self-diagnostics reports are displayed, for 5 seconds each, beginning with the most recent report. Following this display the lamps turn OFF. In order to view the self-diagnostics results again, press the ON/OFF button again.
- The 3 lamps remain OFF if no trouble has occurred.

<IMPORTANT> After self-diagnostics is completed, be sure to press the ACL (reset) button to return to normal mode. The air conditioner will not operate if this is not done.



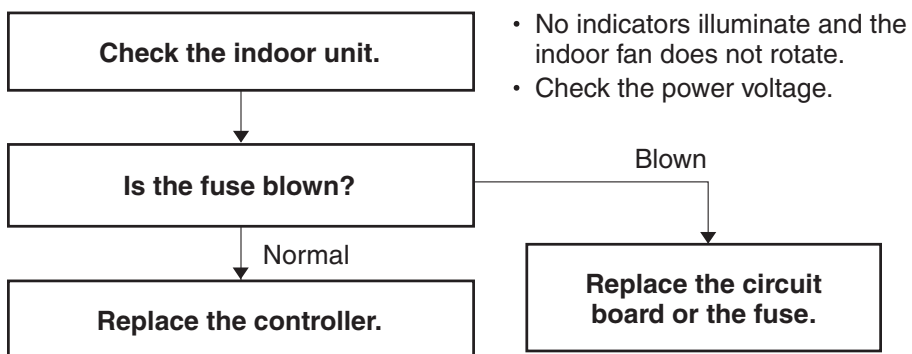
## (1) Self-diagnostics Lamps



• Since the indications cover various units, the corresponding parts listed below may not be present in some models.

INDICATION ON INDOOR UNIT			× ... OFF    ● ... BLINKING    ☀ ... ON		
QUIET (3)	TIMER (2)	OPERATION (1)	CODE	DIAGNOSIS CONTENTS	POSSIBLE MALFUNCTION
×	×	●	S01	ROOM TEMP. SENSOR TROUBLE	(1) OPEN OR SHORT CIRCUIT IN SENSOR
×	●	×	S02	I/D HEAT EXCHANGER TEMP. SENSOR TROUBLE	(2) POOR CONTACT AT CONNECTOR OR OPEN CIRCUIT AT TERMINAL PRESS-FIT LOCATION (FOR HUMIDITY SENSOR, THIS REPRESENTS SHORT-CIRCUIT DETECTION ONLY.)
×	●	●	S03	HUMIDITY SENSOR TROUBLE	(3) I/D PCB FAILURE (I/D = INDOOR)
●	×	×	S04	COMPRESSOR TEMP. SENSOR TROUBLE	(1) OPEN OR SHORT CIRCUIT IN SENSOR
●	×	●	S05	O/D HEAT EXCHANGER TEMP. SENSOR TROUBLE	(2) POOR CONTACT AT CONNECTOR OR OPEN CIRCUIT AT TERMINAL PRESS-FIT LOCATION
●	●	×	S06	O/D AIR TEMP. SENSOR TROUBLE	(3) O/D PCB FAILURE (O/D = OUTDOOR)
●	●	●	S07	O/D CURRENT SENSOR ERROR	O/D PCB FAILURE
×	×	☀	E01	I/D-O/D COMMUNICATION TROUBLE (SERIAL COMMUNICATION TROUBLE)	(1) MIS-WIRING (2) AC POWER FAILURE (3) BLOWN FUSE (4) POWER RELAY FAILURE (5) I/D OR O/D PCB FAILURE (6) O/D FAN MOTOR FAILURE (7) REACTOR FAILURE (8) HIGH-PRESSURE SW FAILURE (9) OLR FAILURE (10) MAGNETIC COIL FAILURE
×	☀	×	E02	HIC CIRCUIT TROUBLE POWER TR CIRCUIT TROUBLE	(1) HIC OR POWER TR FAILURE (2) O/D FAN NOT OPERATING (3) INSTANTANEOUS POWER STOPPAGE (4) SERVICE VALVE NOT OPENED. (5) O/D FAN BLOCKED (6) CONTINUOUS OVERLOAD OPERATION (7) COMPRESSOR FAILURE (8) O/D PCB FAILURE
×	☀	☀	E03	O/D UNIT EXTERNAL ROM TROUBLE	(1) EXTERNAL ROM DATA FAILURE (2) O/D PCB FAILURE
☀	×	×	E04	CURRENT PEAK CUT	(1) INSTANTANEOUS POWER STOPPAGE (2) HIC OR POWER TR FAILURE (3) O/D PCB FAILURE
☀	×	☀	E05	PAM CIRCUIT TROUBLE ACTIVE CIRCUIT TROUBLE	(1) O/D PCB FAILURE (2) O/D POWER VOLTAGE TROUBLE
☀	☀	×	E06	COMPRESSOR DISCHARGE TEMP. OVERHEATING PREVENTION	(1) ELECTRIC EXPANSION VALVE FAILURE (2) CHOKED CAPILLARY TUBE (3) INSUFFICIENT GAS (4) CONTINUOUS OVERLOAD OPERATION (5) O/D FAN NOT OPERATING (6) O/D PCB FAILURE
☀	☀	☀	E07	I/D FAN OPERATION TROUBLE	(1) FAN MOTOR FAILURE (2) CONNECTOR CONTACT FAILURE (3) I/D PCB FAILURE
●	●	☀	E08	4-WAY VALVE SWITCHING TROUBLE ZERO-CROSS TROUBLE	(1) 4-WAY VALVE FAILURE (HEAT PUMP MODEL ONLY) (2) O/D PCB FAILURE
●	☀	●	E09	GAS-LOSS PREVENTION	(1) SERVICE VALVE NOT OPENED (2) INSUFFICIENT GAS
●	☀	☀	E10	DC COMPRESSOR DRIVE CIRCUIT TROUBLE	(1) OPEN PHASE (2) O/D PCB FAILURE
☀	●	●	E11	O/D DC FAN OPERATION TROUBLE	(1) FAN MOTOR FAILURE (2) CONNECTOR CONTACT FAILURE (3) O/D PCB FAILURE
☀	●	☀	E12	O/D SYSTEM COMM FAILURE, OLR OPERATION, O/D POWER OPEN PHASE, O/D FREEZING	(1) MIS-WIRING (2) BLOWN FUSE (3) POWER RELAY FAILURE (4) O/D PCB FAILURE (5) COMPRESSOR FAILURE
☀	☀	●	E13	FREEZING-PREVENTION OPERATION	(1) I/D FAN SYSTEM FAILURE (2) INSUFFICIENT GAS (3) OPERATION AT LOW TEMPERATURE

**(2) If the self-diagnostics function fails to operate**



## 8-3. Checking the Indoor and Outdoor Units

### (1) Checking the indoor unit

No.	Control	Check items (unit operation)
1	Use the remote controller to operate the unit in "TEST run" mode. To determine whether the mode is currently in "TEST run" mode, check the 4 indicator lamps on the unit. If all 4 are blinking, the current mode is "TEST run."	<ul style="list-style-type: none"> <li>The rated voltage must be present between inter-unit wirings 1 and 2.</li> <li>Connect a 5 k ohm resistor between inter-unit wirings 2 and 3. When the voltage at both ends is measured, approximately 12 to 15V DC must be output and the multimeter pointer must bounce once every 8 seconds.</li> </ul> Or instead of measuring the voltage, you can insert an LED jig and check that the LED flickers once every 8 seconds.

- If there are no problems with the above, then check the outdoor unit.
- For the "Test run" procedure, refer to "4. How to Test Run the Air Conditioner" on Appendix B.

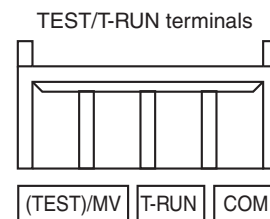
### (2) Checking the outdoor unit

No.	Control	Check items (unit operation)
1	Apply the rated voltage between outdoor unit terminals L1 and L2.	<ul style="list-style-type: none"> <li>The control panel LED (red) must illuminate.</li> </ul>
2	Short-circuit the outdoor unit COM terminal to the T-RUN terminal.	<ul style="list-style-type: none"> <li>The compressor, fan motor, and 4-way valve must all turn on.</li> </ul>

- If there are no problems with the above, then check the indoor unit.

#### ● Using the TEST/T-RUN terminals

- T-RUN : Test run (compressor and fan motor turn ON).  
 TEST/MV : Compresses time to 1/60th (accelerates operation by 60 times faster than normal).



### (3) How to Identify a Serial Communication Error

If the lamps on the main body show the following conditions after the completion of self-diagnosis, a communication error between the indoor unit and outdoor unit might be considered. In such a case, identify the breakdown section by using the following procedure.

**NOTE** Refer to "Method of Self-Diagnosis" for the self-diagnosis procedure.

Condition \ Lamp	Quiet (3)	Timer (2)	Operation (1)
E01	×	×	☀
E12	☀	⦿	☀

× : Off  
 ⦿ : Blinking  
 ☀ : Illuminated

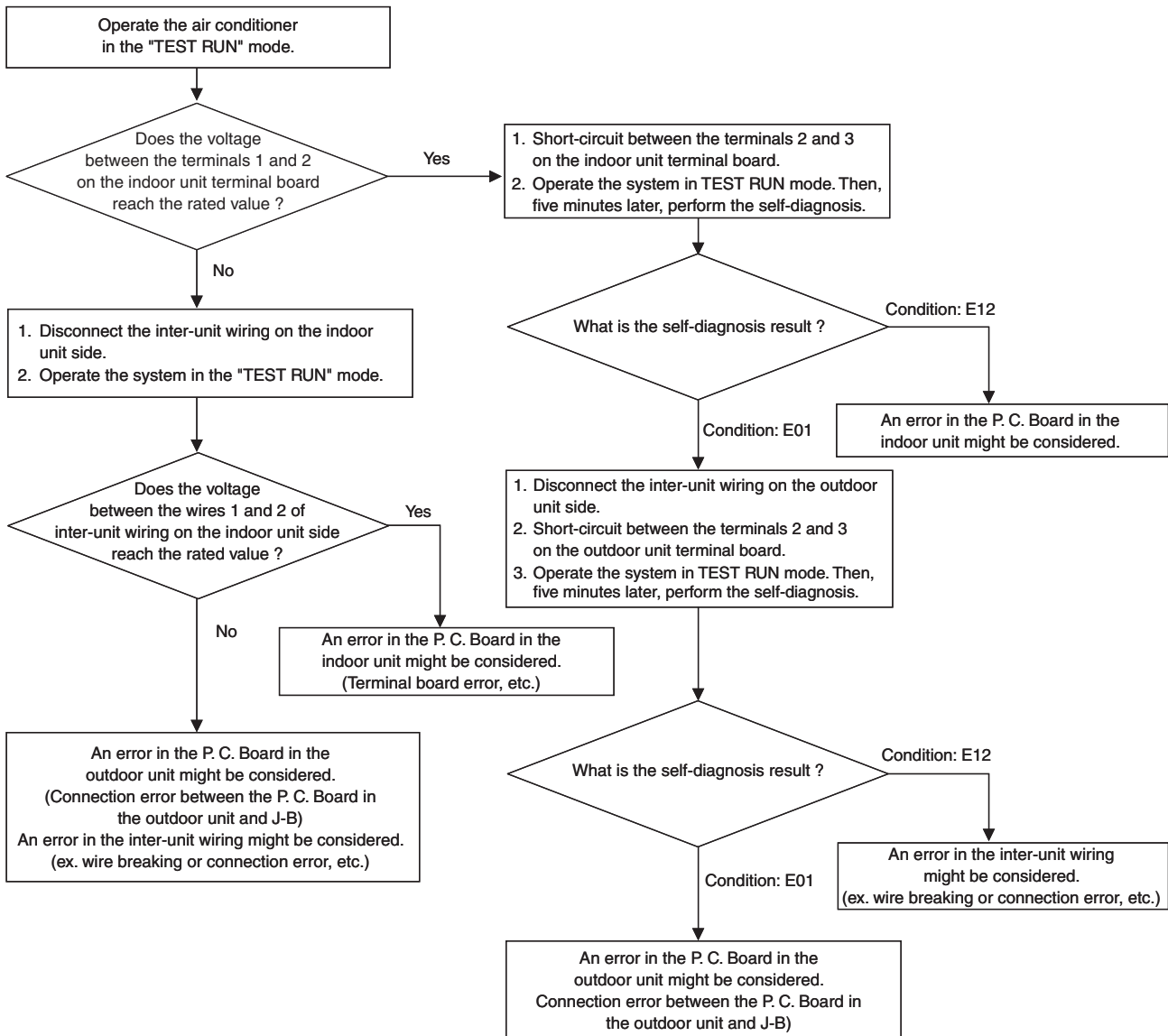
(3-1) Condition: E01



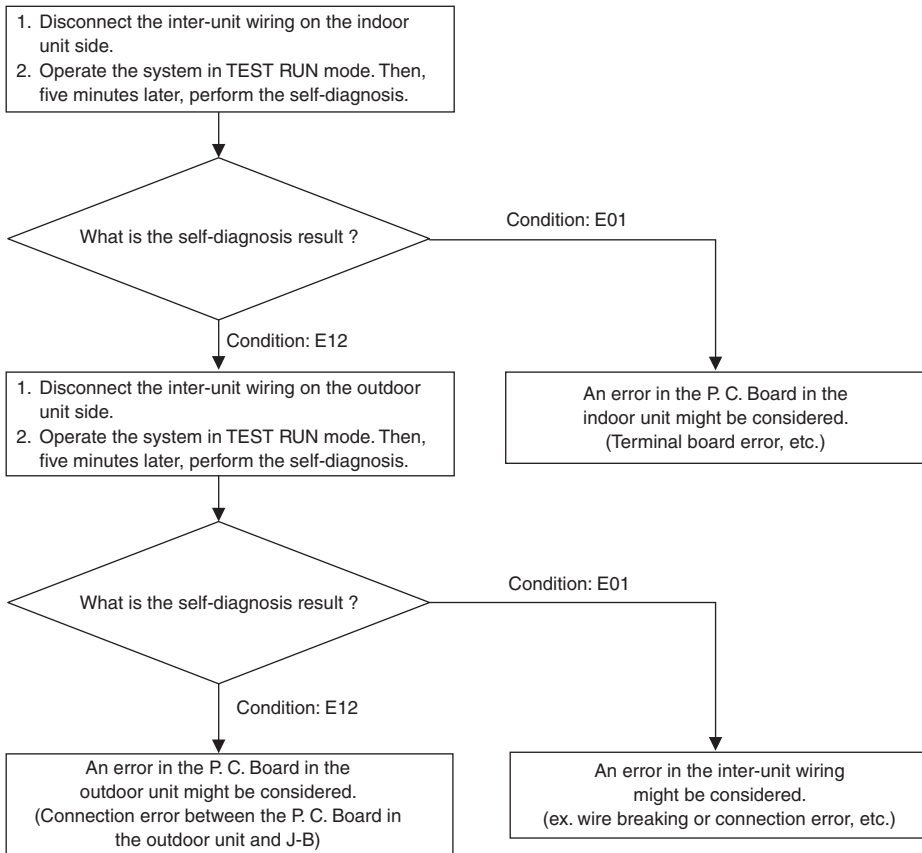
**WARNING**

For terminal board short circuit work or inter-unit wiring removal, turn off the power to avoid an electric shock.

Remove the terminal board short circuit after the completion of self-diagnosis.



(3-2) Condition: E12



## 8-4. Trouble Diagnosis of Fan Motor

### 8-4-1. Indoor Fan Motor

- This indoor DC fan motor contains an internal control PCB. Therefore, it is not possible to measure the coil resistance, and the following procedure should be used to check the motor.
- To perform diagnosis, operate the unit in cooling mode with indoor fan speed "High". Next, make sure that the indoor unit receive the signals from the remote controller when the ON/OFF operation button is pressed.

**Important:** (A) Turn OFF the power before connecting or disconnecting the motor connectors.  
(B) When performing voltage measurement at the indoor controller connector for (3) in the table below, the DC motor will trip and voltage output will stop approximately 1 minute after operation is started. For this reason, to measure the voltage again, turn OFF the unit once using the remote controller, and then start the air conditioner again.

[Trouble symptom 1] The fan does not stop when the unit stops. →Indoor unit controller trouble.

[Trouble symptom 2] The fan motor does not rotate when the unit is operating.

#### (Diagnostic procedure)

\* Disconnect the motor connectors and measure the voltage at the DC motor connectors on the indoor unit controller (3 locations).

Measurement location	Normal value
(1) Vm-Gnd: Between pin 1 and pin 3	DC 230 V or more
(2) Vcc-Gnd: Between pin 4 and pin 3	DC 14 V or more
(3) Vs-Gnd: Between pin 5 and pin 3	Fluctuation between DC 1.7 to 6.1 V

#### (Diagnostic results)

All of the above measured values are normal. → Fan motor trouble (Replace the motor.)

Any one of the above measured values is not normal. → Indoor unit controller trouble (Replace the controller .)

#### (Reference) DC motor connector pin arrangement

Pin 1: Vm (red)  
Pin 2: Not used  
Pin 3: Gnd (black)  
Pin 4: Vcc (white)  
Pin 5: Vs (yellow)  
Pin 6: PG (blue)

[Trouble symptom 3] Motor rotates for some time (several seconds), but then quickly stops, when the indoor unit operates.

(There is trouble in the system that provides feedback of motor rotation speed from the motor to the indoor unit controller.)

[Trouble symptom 4] Fan motor rotation speed does not change during indoor unit operation.

[Trouble symptom 5] Fan motor rotation speed varies excessively during indoor unit operation.

#### (Remedy for symptom 3 to 5)

It is not possible to identify whether the trouble is indoor unit controller trouble or motor trouble. Therefore, first replace the indoor unit controller, then (if necessary) replace the DC motor.

## 8-5. Noise Malfunction and Electromagnetic Interference

An inverter A/C operates using pulse signal control and high frequencies. Therefore, it is susceptible to the effects of external noise, and is likely to cause electromagnetic interference with nearby wireless devices.

A noise filter is installed for ordinary use, preventing these problems. However, depending on the installation conditions, these effects may still occur. Please pay attention to the points listed below.

### (1) Noise malfunction

This refers to the application of high-frequency noise to the signal wires, resulting in abnormal signal pulses and malfunction.

Locations most susceptible to noise	Trouble	Correction
<ol style="list-style-type: none"> <li>Locations near broadcast stations where there are strong electromagnetic waves</li> <li>Locations near amateur radio (short wave) stations</li> <li>Locations near electronic sewing machines and arc-welding machines</li> </ol>	<p>Either of the following trouble may occur.</p> <ol style="list-style-type: none"> <li>The unit may stop suddenly during operation.</li> <li>Indicator lamps may flicker.</li> </ol>	<p>(The fundamental concept is to make the system less susceptible to noise.)</p> <p>- Insulate for noise or distance from the noise source. -</p> <ol style="list-style-type: none"> <li>Use shielded wires.</li> <li>Move unit away from the noise source.</li> </ol>

### (2) Electromagnetic interference

This refers to noise generated by high-speed switching of the microcomputer and compressor. This noise radiates through space and returns to the electric wiring, affecting any wireless devices (televisions, radios, etc.) located nearby.

Locations most susceptible to noise	Trouble	Correction
<ol style="list-style-type: none"> <li>A television or radio is located near the A/C and A/C wiring.</li> <li>The antenna cable for a television or radio is located close to the A/C and A/C wiring.</li> <li>Locations where television and radio signals are weak.</li> </ol>	<ol style="list-style-type: none"> <li>Noise appears in the television picture, or the picture is distorted.</li> <li>Static occurs in the radio sound.</li> </ol>	<ol style="list-style-type: none"> <li>Select a separate power source.</li> <li>Keep the A/C and A/C wiring at least 1 meter away from wireless devices and antenna cables.</li> <li>Change the wireless device's antenna to a high-sensitivity antenna.</li> <li>Change the antenna cable to a BS coaxial cable.</li> <li>Use a noise filter (for the wireless device).</li> <li>Use a signal booster.</li> </ol>



# Limited Warranty (ONLY FOR U.S.A. AND PUERTO RICO)

Panasonic Air Conditioning Group  
Division of Panasonic Corporation of North America  
1165 Allgood Road NE, Suite 22, Marietta, GA 30062

## Panasonic Air Conditioner Products Parts Limited Warranty

### Limited Warranty Coverage (For USA Only)

Panasonic Air Conditioning Group, ("PACG") warrants to the original purchaser of every new Panasonic HVAC Product purchased and used in the fifty states of the United States and the District of Columbia that all controllers thereof (except cabinets, accessories or knobs) will be free from defects in materials or workmanship, as hereinafter provided, for one (1) year from the date it was first purchased. PACG will, at its option, repair or replace the HVAC Product or any of its parts covered by this warranty which becomes defective, malfunctions or otherwise fails to conform to this warranty under normal use and service during the term of this warranty, at no charge for parts.

PACG further warrants to the original purchaser of every new Panasonic HVAC Product purchased and used in the fifty states of the United States and the District of Columbia that all parts thereof (except cabinets, accessories, knobs, filters, controllers or compressors) will be free from defects in materials or workmanship, as hereinafter provided, for five (5) year from the date it was first purchased. PACG will, at its option, repair or replace the HVAC Product or any of its parts covered by this warranty which becomes defective, malfunctions or otherwise fails to conform to this warranty under normal use and service during the term of this warranty, at no charge for parts.

PACG further warrants to the original purchaser of every new Panasonic HVAC Product purchased and used in the fifty states of the United States and the District of Columbia that the compressor thereof will be free from defects in materials or workmanship, as hereinafter provided, for seven (7) years from the date the HVAC Product was first purchased. PACG will, at its option, repair or replace the HVAC Product's compressor covered by this warranty which becomes defective, malfunctions or otherwise fails to conform to this warranty at no charge for parts during the term of this warranty and at no charge for limited labor during the thirty (30) days following the date it was first purchased.

Limited Labor	Parts
30 days (compressor only)	Seven (7) year (compressor only)
	Five (5) year (parts other than compressor, except controllers)
	One (1) year (controllers only)

### Exercising Your Warranty:

In order to obtain warranty service, the HVAC Product, together with the original or a machine reproduction of the bill of sale or other dated, proof-of-purchase document describing the HVAC Product, must be delivered (at the owner's expense) to or serviced by an Authorized Panasonic HVAC Product Servicer in the United States. Uncrating, setup, installation, removal for repair or reinstallation after repair are not covered. Any evidence of alteration, erasing or forgery of proof-of-purchase documents will be cause to void the warranty. The names and addresses of Authorized Panasonic HVAC Product Servicers may be obtained by visiting our Web Site or calling the toll-free number listed at the end of this sheet.

### Limited Warranty Limits and Exclusions

This warranty ONLY COVERS failures due to defects in materials or workmanship, and does not cover defects, malfunctions or failures caused by or resulting from a cause beyond PACG's control, including, but not limited to, shipping or transit accidents, abuse, misuse, neglect, accident, operation on incorrect power supplies, maladjustment of customer-operated controls as explained in the instruction manual, operation with

faulty associated equipment, modification, alteration, improper maintenance or servicing, uncrating, setup, installation, removal, reinstallation, tampering, operating the product in a corrosive atmosphere containing chlorine, fluorine, or any other chemicals, improper maintenance, power line surge, lightning damage, introduction of sand, humidity or liquids, fire, flood or other acts of God or normal wear and tear.

This is the only warranty applicable to Panasonic HVAC Products; PACG neither assumes nor authorizes anyone to assume for it any other warranty. **THIS WARRANTY IS EXPRESSLY IN LIEU OF ANY OTHER WARRANTIES, EXPRESS OR IMPLIED, INCLUDING ANY IMPLIED WARRANTY OF MERCHANTABILITY OR FITNESS FOR A PARTICULAR PURPOSE, AND OF ANY OTHER OBLIGATIONS OR LIABILITY ON THE PART OF PACG. PACG'S LIABILITY FOR ANY AND ALL LOSSES AND DAMAGES RESULTING FROM ANY CAUSE WHATSOEVER, INCLUDING PACG'S NEGLIGENCE, ALLEGED, DAMAGED OR DEFECTIVE GOODS, WHETHER SUCH DEFECTS ARE DISCOVERABLE OR LATENT, SHALL IN NO EVENT EXCEED THE PURCHASE PRICE OF THE PRODUCT. IN NO EVENT SHALL PACG BE LIABLE FOR LOSS OF USE, COMMERCIAL LOSS OR OTHER INCIDENTAL OR CONSEQUENTIAL DAMAGES WHATSOEVER. PACG IS NOT LIABLE FOR INCIDENTAL OR CONSEQUENTIAL DAMAGES RESULTING FROM THE USE OF THIS PRODUCT, OR ARISING OUT OF ANY BREACH OF THIS WARRANTY.** (As examples, this excludes damages for lost time; parts used in connection with normal maintenance such as air filters and owner-required maintenance. The items listed are not exclusive, but for illustration only.)

**ALL EXPRESS AND IMPLIED WARRANTIES, INCLUDING THE WARRANTY OF MERCHANTABILITY, ARE LIMITED TO THE PERIOD OF THE LIMITED WARRANTY.**

Some states do not allow the exclusion or limitation of incidental or consequential damages, or limitations on how long an implied warranty lasts, so the exclusions may not apply to you.

This warranty gives you specific legal rights and you may also have other rights which vary from state to state. If a problem with this product develops during or after the warranty period, you may contact your authorized HVAC contractor or distributor.

**PARTS WHICH ARE NOT COVERED BY THIS LIMITED WARRANTY, INCLUDING WITHOUT LIMITATION THE COST OF AN IN-HOME OR IN-BUILDING SERVICE CALL, ARE YOUR RESPONSIBILITY.**

**Customer Services Directory (United States and Puerto Rico)**

**Obtain Product Information and Operating Assistance; locate your nearest Dealer or Service Center by visiting our Web Site at:**

<http://www.panasonic.com/help>

**or, contact us via the web at:**

<http://www.panasonic.com/contactinfo>

You may also contact us directly at:

1-800-211-PANA (7262)

Monday-Friday 9am-9pm, Saturday-Sunday 10am-7pm EST

**For hearing or speech impaired TTY users, TTY: 1-877-833-8855**

**As of October 2011**

85164519302000